

EXCELUNITEK

# EXCEL EXCELLINE

Unitek Ferri Claudio srl

61012 Gradara \_PU Italia  
Via G. Santi 32  
+39.0541.969002  
[www.uniteklevigatrici.it](http://www.uniteklevigatrici.it)  
[Info@uniteklevigatrici.it](mailto:Info@uniteklevigatrici.it)



# SPECIALISTI PER IL LEGNO WOOD SPECIALISTS

Unitek Fondata nel 1977 da Claudio Ferri, ha consolidato la sua presenza nel mercato delle levigatrici e calibratrici per l'industria del legno, grazie anche all'utilizzo di propri brevetti, con una capacità produttiva flessibile. Le tre linee di produzione Nice, Winner ed Excel sono in grado di soddisfare le esigenze tecniche dell'artigiano, della media e grande industria. Inoltre Excel Line può essere inserita in linee automatiche di produzione per grossi carichi di lavoro. Una rete di distributori e la capacità di assistenza completano i vantaggi di Unitek.



Founded by Claudio Ferri in 1977, has consolidated its presence on the market for calibrating and sanding machines for the woodworking industry, supported by its own patents, with flexible production capacity. The three product lines, Nice, Winner and Excel, are able to meet the technical requirements of craftsmen and medium-sized and large industrial concerns alike. What's more, the Excel Line can be included in automatic production lines for large workloads. Unitek's advantages are completed by an network of distributors and impressive service capability.



Das 1977 von Claudio Ferri gegründete Unternehmen konnte seine Präsenz auf dem Markt der Kalibrier- und Schleifmaschinen für die Holzindustrie auch dank der Entwicklung eigener Patente und der flexiblen Produktionskapazität schnell konsolidieren. Die drei Produktionslinien Nice, Winner und Excel tragen den Erfordernissen von Handwerkern ebenso Rechnung wie jenen von klein- und mittelständischen Unternehmen sowie großen Industriebetrieben. Die Excel Line kann auch problemlos in automatische Fertigungsstraßen für große Produktionsmengen integriert werden. Ein engmaschiges Verteiler- und Kundendienstnetz rundet das Angebot von Unitek ab.



Fondée en 1977 par Claudio Ferri, la société Unitek s'est imposée sur le marché des ponceuses et calibreuses pour l'industrie du bois, grâce notamment à l'utilisation de ses brevets, avec une capacité de production flexible. Les trois lignes de production Nice, Winner et Excel sont en mesure de répondre aux besoins techniques des artisans, de la grande et moyenne industrie. De plus, Excel Line peut être insérée dans des lignes de production automatiques pour les charges de travail élevées. Un réseau de distributeurs et un service après-vente mobilisé complètent les avantages offerts par Unitek.



Fundada en 1977 por Claudio Ferri, Unitek ha consolidado su posición en el mercado de las pulidoras y calibradoras para la industria de la madera gracias, entre otros factores, al uso de sus propias patentes y una capacidad de producción sumamente versátil. Sus tres líneas de producción –Nice, Winner y Excel– logran responder a las exigencias técnicas tanto de los artesanos como de la mediana y grande industria. Asimismo, Excel Line puede instalarse dentro de líneas automáticas de alto rendimiento para grandes producciones. Entre las ventajas de Unitek, cabe mencionar también una válida red de distribuidores y de asistencia técnica.



Unitek  
+39.0541.969002  
uniteklevigatrici.it





# EXCELEXCELLINE

Serie Excel/Excel Line. Levigatrice/Calibratrice per lavorazione del legno utilizzabile anche in linee di lavoro automatiche, per carichi di lavoro di produzioni industriali in piena sicurezza. Alte performance a ridotto consumo di energia e bassa manutenzione. Robusta e flessibile grazie alla possibilità di montare rulli di diametro elevato e sviluppo nastro lungo.



## FORTE E POTENTE STRONG AND POWERFUL



Series Excel/Excel Line. Sanding/calibrating woodworking machine also suitable for inclusion in automatic lines, to handle industrial workloads in complete safety. High performance with low energy consumption and maintenance. Rugged and versatile, thanks to the ability to take large-diameter rollers and long belts.



Serie Excel/Excel Line. Zuverlässige Schleif- und Kalibriermaschinen zur Holzbearbeitung, auch zur Integration in automatische Fertigungsstraßen für große industrielle Produktionsmengen. Hohe Leistung bei niedrigem Energieverbrauch und geringem Wartungsbedarf. Robust und flexibel, auch für große Walzendurchmesser und Bandmaße.



Série Excel/Excel Line. Ponceuse/Calibreuse pour l'usinage du bois utilisable dans des lignes de travail automatiques, pour les charges de travail de productions industrielles en toute sécurité. Performances élevées, faible consommation d'énergie et entretien réduit. Robuste et flexible grâce à la possibilité de monter des rouleaux de gros diamètre et d'ajuster la longueur de la bande.



Serie Excel/Excel Line. Pulidora/Calibradora para la elaboración de la madera que también puede incorporarse en líneas de mecanizado automático para grandes producciones industriales en plena seguridad. Alto rendimiento con bajo consumo de energía y escaso mantenimiento. Fuerte y versátil, gracias a la posibilidad de montar rodillos de gran diámetro y cintas transportadoras de gran longitud.



h 2025 - 2250

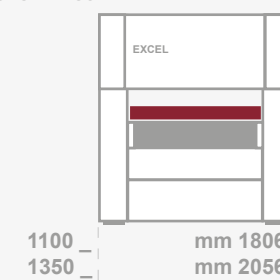

h 2225 - 2250

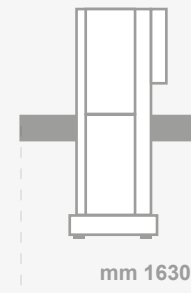
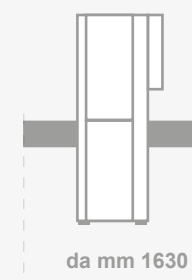
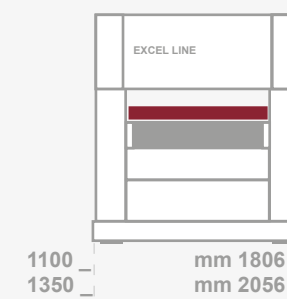



 Tecnologia e qualità costruttive per una lunga durata e alte performance nelle lavorazioni.

**01 Struttura** massiccia con basamento monoscocca in acciaio a grande spessore, travi centrali saldate alla base, per una grande rigidità strutturale e precisione di lavoro.

**02 Sollevamento Piano** trasportatore a 4 pistoni, fissaggio a 4 lati sul corpo macchina, unico nel settore.

**03 Trasportatore** per tappeto gommato in acciaio elettrosaldato, nervato, ampio e rettificato.

**04 Regolazione micrometrica del piano.**

**05 Sistema traslazione nastro** a Brevetto Unitek. Non necessita di aria compressa o di alimentazione elettrica.

**Ampia gamma** di configurazioni ed optional.

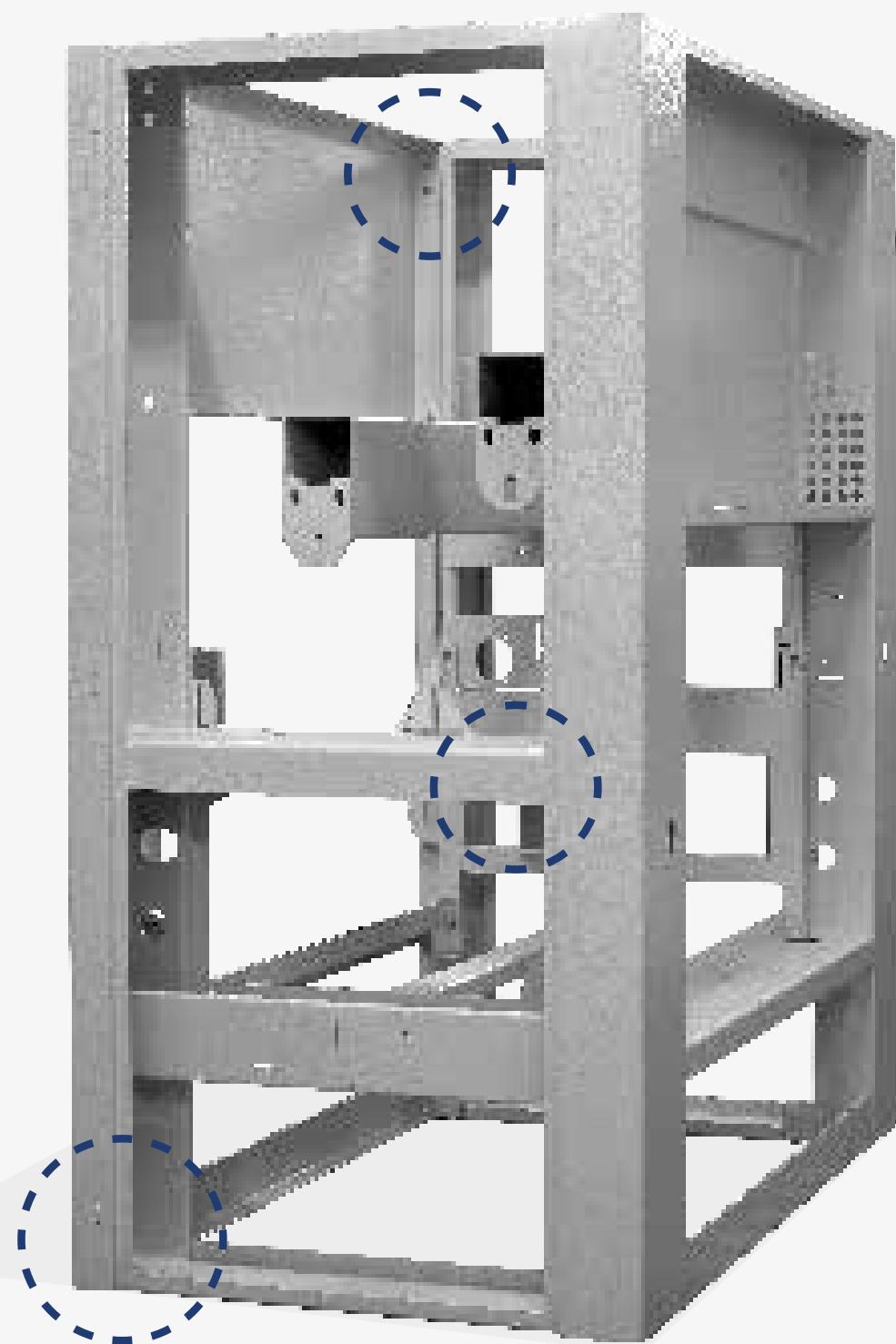

01

05



## VALORI E VANTAGGI VALUES AND BENEFITS



Construction technology and quality for a long working life and outstanding processing performances.

**01 Structure** very solid with extra-thick one-piece steel base, central beams welded to base, for top-grade structural stability and processing precision.

**02 Conveyor table lifting** system with 4 pistons, secured to body of machine on 4 sides, industry-unique.

**03 Large, ground conveyor table** supporting the rubber-coated belt, with stiffener ribs.

**04 Micrometric table height adjustment.**

**05 Unitek patented belt drive system.** No compressed air electricity supply required.

**Wide range** of configurations and optionals.



Modernste Technologie und beste Qualität sind unsere Garantien für lange Nutzungsdauer und höchste Leistungen.

**01 Unterbau:** massives Bett mit Verbundrahmen aus dickwandigem Stahl und angeschweißten mittleren Querbalken, für hohe strukturelle Steifigkeit und präzises Arbeiten.

**02 Tischanhebung** mit 4 Kolben, allseitige Befestigung am Maschinenkorpus, einzigartig in der Branche.

**03 Förderer** für gummiertes Breitband, aus elektrogeschweißtem, geschliffenem und geripptem Stahl.

**04 Präzise Feineinstellung der Arbeitsfläche**

**05 Bandverfahrensystem** mit Unitek-Patent, ohne Pressluft und ohne Strom.

**Breit gefächerte Palette** von Konfigurationen und Optionals.



Technologie et qualités constructives pour une longue durée de vie et des performances d'usage élevées.

**01 Structure** massive avec bâti monobloc en acier de grosse épaisseur, poutres centrales soudées à la base, pour une grande rigidité structurale et précision de travail.

**02 Levage Table** convoyeur à 4 pistons, fixation à 4 côtés sur le corps machine, unique dans le secteur.

**03 Convoyeur** pour tapis en caoutchouc en acier soudé électriquement, nervuré, large et rectifié.

**04 Réglage micrométrique de la table.**

**05 Système translation bande** avec Brevet Unitek. Ne nécessite ni air comprimé ni alimentation électrique.

**Large gamme** de configurations et d'options.



02



03



04



Tecnología y características de construcción que garantizan larga duración y mecanizaciones de alto rendimiento.

**01 Estructura** maciza, con bancada monobloque de acero de gran espesor y travesaños centrales soldados a la base para una gran rigidez estructural y alta precisión de funcionamiento.

**02 Sistema de elevación de la mesa** transportadora mediante 4 pistones fijado al cuerpo de la máquina en los 4 lados, único en el sector.

**03 Transportador** de cinta engomada construido en acero electrosoldado, nervado y rectificado de grandes dimensiones.

**04 Ajuste micrométrico de la mesa.**

**05 Sistema de traslación de la cinta** con patente Unitek. No requiere aire comprimido ni suministro eléctrico.

**Vasta gama** de configuraciones y accesorios opcionales.

# GRUPPI OPERATORI MACHINING UNITS



**06**

Spazzola spolveratore, rusticatore, tinex, rusticatore in acciaio.  
Dust remover brush, Tinex coarse sander, steel coarse sander.  
Staubbürste, Rustikator Tinex, Rustikator aus Stahl.  
Brosse dépoussiéreuse, machine à vieillir le bois tynex, machine à vieillir le bois en acier.  
Cepillo desempolvador, rusticador de Tynex, rusticador de acero.



06



07



08

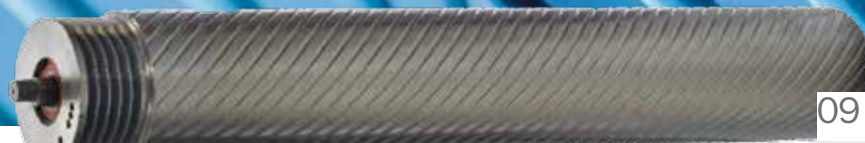

09

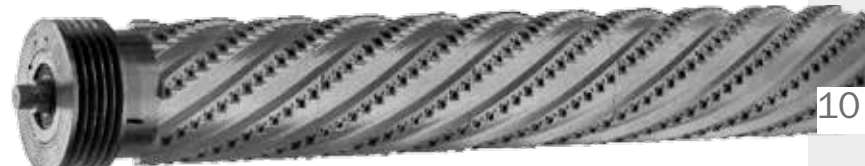

10

**07**

Satinatore o scotch brite  
Scotch brite or satin finish sander  
Satinierwalze oder Scotch-Brite  
Satineuse ou scotch brite  
Satinador o Scotch-Brite

**08**

Rullo levigatore  
Sanding roller  
Schleifwalze  
Rouleau ponceur  
Rodillo pulidor

**09**

Rullo calibratore in acciaio o gomma  
Steel or rubber calibrating roller  
Kalibrierwalze aus Stahl oder Gummi  
Rouleau calibreur en acier ou caoutchouc  
Rodillo calibrador de acero o goma

**10**

Rullo pialla  
Planing roller  
Hobel  
Rouleau raboteur  
Rodillo regruesador

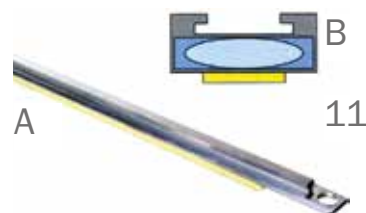

11

**11**

Tampone finitore, utilizzato per la finitura e levigatura, indicato per superfici in legno massello e impiallacciato. A\_ Tampone rigido per legno massello. B\_ Tampone elastico a camera d'aria per legno impiallacciato.

Polishing pad. The pad is used for polishing and sanding surfaces. Particularly suitable for solid and veneered wood surfaces. A\_ Rigid pad for solid wood. B\_ Flexible pad with air cushion for veneered wood.

Schuh für den Fein- und Endschliff der Oberflächen, speziell für Massivholz und Furnier. A\_ Starrer Schuh für Massivholz. B\_ Elastischer Schuh mit Luftkammer für furniertes Holz.

Patin de finition. Le patin est utilisé pour la finition et le ponçage des surfaces. Particulièrement indiqué pour les surfaces en bois massif et plaqué. A\_ Patin rigide pour bois massif. B\_ Patin élastique gonflable pour bois plaqué.

Tampón de acabado. El tampón se utiliza para acabar y pulir las superficies. Sumamente indicado para las superficies de madera maciza o enchapadas. A\_ Tampón rígido para madera maciza. B\_ Tampón elástico con cámara de aire para madera enchapada.

12



**12**

Tampone finitore versione elettronico-pneumatica per la lavorazione di superfici con variazione di spessori concavi o convessi. Consente la levigatura uniforme di tutta la superficie grazie alla programmazione automatica e diversificata della pressione dei tamponi in entrata ed in uscita pezzo, permettendo la lavorazione contemporanea di più pezzi.

Endschliffschuh, elektronische-pneumatische Ausführung zur Bearbeitung von unregelmäßigen Oberflächen mit konkaven oder konvexen Formen. Dank der automatischen und diversifizierbaren Schleifdruckprogrammierung an der Werkstückauf- und -abgabe wird eine gleichmäßige Bearbeitung über die gesamte Fläche erzielt. Simultane Bearbeitung mehrerer Werkstücke.

Tampón de acabado en versión electrónica-neumática para la mecanización de superficies irregulares de espesor heterogéneo. Permite el pulido homogéneo de toda la superficie gracias a la programación automática e independiente de la presión de los tampones a la entrada y a la salida de la pieza, para la mecanización de varias piezas a la vez.

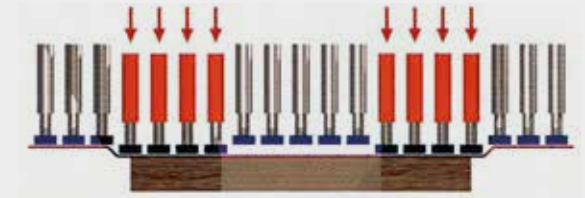

Electronic-pneumatic polishing pad for processing concave or convex surfaces. Provides uniform processing of the entire surface thanks to automatic, diversified programming of entry and exit pads, allowing simultaneous processing of more than one piece.

Patin de finition version électronique-pneumatique pour l'usinage de surfaces avec variation d'épaisseurs concaves ou convexes. Permet de réaliser un ponçage uniforme de toute la surface grâce à la programmation automatique et diversifiée de la pression des patins en entrée et sortie pièce, et l'usinage simultané de plusieurs pièces.



15



**15**  
2N RKRT

16

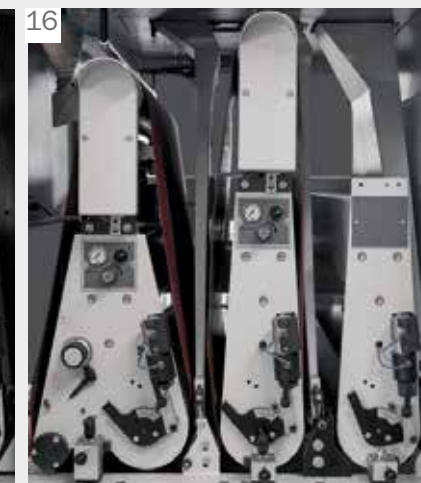

**16**  
3N RRKRT

17



**17**  
4N RRRR

Esempi di configurazione  
Configuration examples  
Konfigurationsbeispiele  
Exemples de configuration  
Ejemplos de configuración



19

Gruppo centraggio tappeto  
Conveyor belt centring unit  
Bandzentrierung  
Groupe centrage tapis  
Unidad de centrado cinta

20

Motore variatore velocità  
Variable speed conveyor belt drive  
Bandmotor  
Motore variatore velocità  
Motore variador cinta

## EXCEL STANDARD



19



20



30

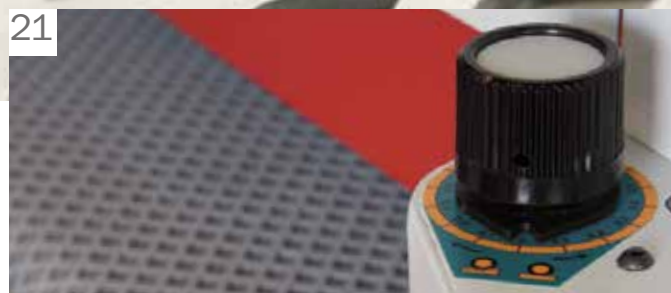

21



22



### Excel Dotazioni Standard

Posizionatore automatico del piano  
Centraggio automatico tappeto  
Motore variatore velocità  
Bocca di aspirazione Ø 160mm ogni nastro  
Rullo levigatore  
Rullo calibratore in acciaio o in gomma  
Esclusione dei rulli levigatori da quadro comandi  
Centraggio/oscillazione nastro brevettato  
Sviluppo nastri 2150 mm (optional 2620mm)  
Gruppi operatore a tampone (configurazione a richiesta)  
Freno per arresto rotazione nastro  
Rulli tenditori nastro adattivo  
Visualizzatore elettronico di spessore  
Barra antinfortunistica anteriore con limitatore di passata  
Carter di protezione del tappeto  
Macchina a normativa CE



### Excel Standardausstattung

Automatische Tischpositionierung  
Automatische Bandzentrierung  
Verstelltriebemotor für Band  
Ansaugstutzen Ø 160mm für jedes Band  
Schleifwalze  
Kalibrierwalze aus Stahl oder Gummi  
Ausschluss der Schleifwalzen auf dem Steuerpult  
Patentierter Bandzentrierung/Oszillation  
Bandmaß 2150 mm (Optional 2620mm)  
Arbeitsaggregate mit Schuhen (Koffiguration auf Anfrage)  
Bandbremse  
Spannrollen  
Elektronische Dickenanzeige  
Vordere Bedienschutzstange mit Durchgriffsbegrenzung  
Bandeinhausung  
CE-Kennzeichnung

21

Posizionatore automatico piano  
Automatic table positioner  
Automatische Tischpositionierung  
Positionneur automatique table  
Posicionador automático mesa

22

Barra antinfortunistica  
Safety bar  
Bedienschutzstange  
Barre de sécurité  
Barra de seguridad

30

Esclusione pneumatica rulli da quadro comando  
Pneumatic roller cut-out from control panel  
Pneumatische Walzenausschließung auf dem Steuerpult  
Exclusion pneumatique rouleaux depuis tableau de commande  
Desactivación neumática rodillos desde cuadro de mando



### Excel Standard Equipment

Automatic table positioner  
Automatic conveyor belt centring  
Variable speed conveyor belt drive  
Suction inlet Ø 160mm on each sanding belt  
Sanding roller  
Steel or rubber calibrating roller  
Sanding roller cut-out from control panel  
Patented sanding belt centring/positioning system  
Sanding belt length 2150 mm (optional 2620mm)  
Pad processing units (configuration to order)  
Sanding belt stop brake  
Adaptive sanding belt stretcher rollers  
Electronic thickness display  
Front safety bar with pass limiter  
Conveyor belt guard  
Machine to EC standards



### Excel Equipements Standards

Positionneur automatique de la table  
Centrage automatique tapis  
Motore variatore velocità  
Orifice d'aspiration Ø 160 mm pour chaque bande  
Rouleau ponceur  
Rouleau calibreur en acier ou en caoutchouc  
Exclusion des rouleaux ponceurs depuis tableau de commande  
Centrage/oscillation bande brevetée  
Longueur bandes 2150 mm (option 2620 mm)  
Unités d'usinage à patin (configuration sur demande)  
Frein d'arrêt rotation bande  
Rouleaux tendeurs bande adaptative  
Afficheur électronique d'épaisseur  
Barre de sécurité avant avec limiteur de passage  
Carter de protection du tapis  
Machine conforme aux normes CE



### Excel Equipamiento Estándar

Posicionador automático mesa  
Centrado automático cinta  
Motore variador cinta  
Boca de aspiración Ø 160mm por cada cinta  
Rodillo pulidor  
Rodillo calibrador de acero o goma  
Desactivación rodillos pulidores desde cuadro de mando  
Centrado/oscilación cinta patentado  
Longitud cintas: 2150 mm (acc. opcional: 2620 mm)  
Unidad operadora de tampón (configuración bajo pedido)  
Freno rotación cinta  
Rodillos tensores cinta adaptable  
Visualizador electrónico de espesor  
Barra de seguridad anterior con restricción de paso  
Cáster de protección cinta  
Máquina conforme con normativa CE



# EXCEL OPTIONAL



**23**  
 Gruppo rullo pialla  
 Planing roller unit  
 Hobelwalzenaggregat  
 Groupe rouleau raboteur  
 Unidad rodillo regruesador

23



24

**24**  
 Piano estraibile allungabile  
 Extending pull-out table  
 Verlängerbarer Ausziehtisch  
 Table amovible à rallonges  
 Mesa de extensión extraíble



25

**25**  
 Soffiatore oscillante  
 Mobile blower unit  
 Oszillierende Abblasung  
 Souffleuse oscillante  
 Soplador oscilatorio

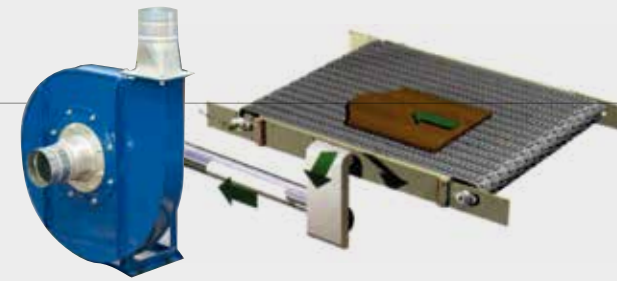

26

**26**  
 Aspirazione per piano depressione  
 Suction system for vacuum table  
 Absaugung für Tischunterdruck  
 Aspiration pour plan dépression  
 Aspiración para mesa de vacío

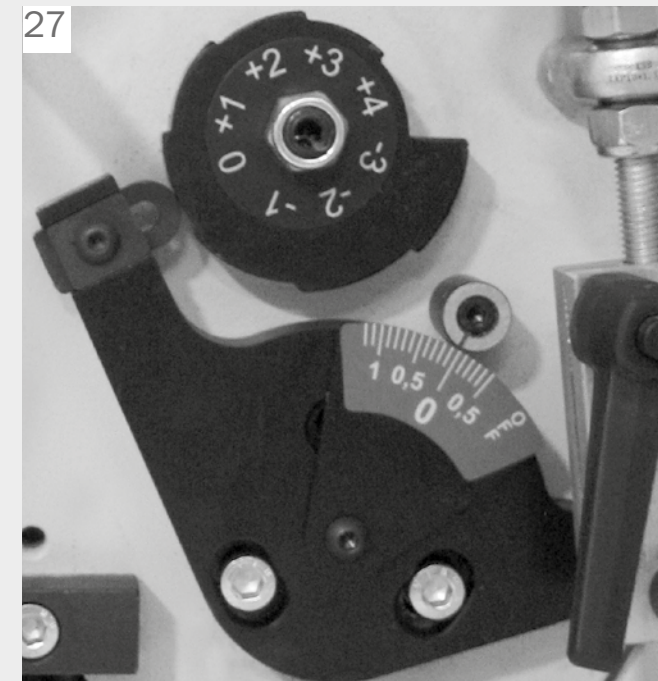

27

**22**  
 Touch screen  
**27**  
 Grit set



22

**28**  
 Pressori a scarpetta per pezzi corti  
 Presser shoes for short pieces  
 Niederhalter für kurze Werkstücke  
 Presseurs à sabot pour pièces courtes  
 Zapatas prensoras para piezas cortas

**29**  
 Gruppo 2°,3° motore  
 2nd and 3rd motor unit  
 Gruppe 2., 3. Motor  
 Groupe 2ème, 3ème moteur  
 Unidad 2°, 3° motor



29

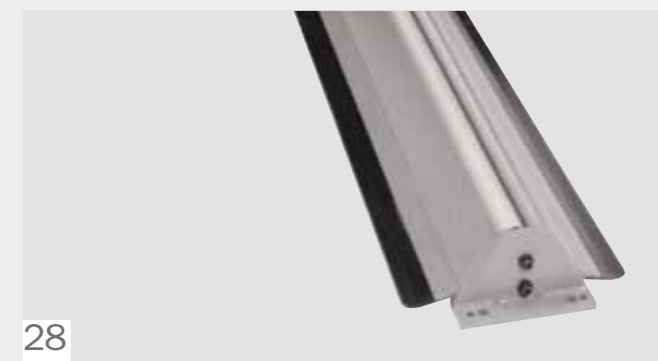

28

# EXCEL OPTIONAL



## Excel Optional

\_ Motori con potenza maggiorata  
 \_ Motori nastro a 2 velocità  
 \_ Sviluppo nastri 2620mm  
 \_ 3 motori indipendenti in versione 3 nastri  
 \_ Motovariatore velocità nastri con inverter  
 \_ Tampone supplementare elastico e temporizzato  
 \_ Tampone sezionato elettronico  
 \_ Tampone sezionato pneumatico con temporizzazione  
 \_ Piano estraibile  
 \_ Rullo spazzola, rusticatore tinex, rusticatore in acciaio  
 \_ Rullo satinatore  
 \_ Rulli temporizzati  
 \_ Gruppo rullo pialla  
 \_ Pressori a scarpetta con rullo incorporato  
 \_ indicato per lavorazione pezzi corti  
 \_ Gruppo soffiatori oscillanti per pulizia nastri temporizzata  
 \_ Piano tappeto a depressione  
 \_ Grit Set per memorizzazione gradi asportazione  
 \_ Check control  
 \_ Touch Screen



## Excel Optionals

\_ Higher power motors  
 \_ 2-speed sanding belt motors  
 \_ Sanding belt length 2620mm  
 \_ 3 independent motors in 3 belt version  
 \_ Variable speed sanding belt drive with inverter  
 \_ Time-controlled, flexible additional pad  
 \_ Electronic sectional pad  
 \_ Time-controlled pneumatic sectional pad  
 \_ Pull-out table  
 \_ Brush roller, Tinex coarse sander, steel coarse sander  
 \_ Satin finishing roller  
 \_ Time-controlled rollers  
 \_ Planing roller unit  
 \_ Presser shoes with integral roller  
 \_ suitable for processing short pieces  
 \_ Mobile blower unit for time-controlled sanding belt cleaning  
 \_ Vacuum conveyor belt table  
 \_ Grit Set for removal depth memorisation  
 \_ Check control  
 \_ Touch Screen



## Excel Options

\_ Moteurs avec puissance augmentée  
 \_ Moteurs bande à 2 vitesses  
 \_ Longueur bandes 2620mm  
 \_ 3 moteurs indépendants version 3 bandes  
 \_ Motovariateur vitesse bandes avec onduleur  
 \_ Patin supplémentaire élastique et temporisé  
 \_ Patin sectionné électronique  
 \_ Patin sectionné pneumatique avec temporisation  
 \_ Table amovible  
 \_ Rouleau brosse, machine à vieillir tydex,  
 \_ machine à vieillir en acier  
 \_ Rouleau satineur  
 \_ Rouleaux temporisés  
 \_ Groupe rouleau raboteur  
 \_ Presseurs à sabot avec rouleau incorporé  
 \_ pour usinage pièces courtes  
 \_ Groupe soufflées oscillantes  
 \_ pour nettoyage temporisé des bandes  
 \_ Plan tapis à dépression  
 \_ Grit Set pour mémorisation degrés enlèvement de matériau  
 \_ Check control  
 \_ Touch Screen



## Excel Optionals

\_ Stärkere Motoren  
 \_ Bandmotoren mit zwei Geschwindigkeiten  
 \_ Bandmaß 2620mm  
 \_ 3 unabhängige Motoren für 3-Band-Version  
 \_ Verstelltriebemotor mit Inverter für Bandgeschwindigkeit  
 \_ Zusätzlicher elastischer, einsetzgesteuerter Schleifschuh  
 \_ Elektronischer Sektionalschuh  
 \_ Pneumatischer Sektionalschuh mit Einsatzsteuerung  
 \_ Ausziehtisch  
 \_ Bürstwalze, Tinex-Rustikator, Rustikator aus Stahl  
 \_ Satinierwalze  
 \_ Einsatzgesteuerte Walzen  
 \_ Hobelwalzenaggregat  
 \_ Niederhalterschuh mit integrierter Walze  
 \_ für kurze Werkstücke  
 \_ Oszillierende Abblasung  
 \_ für die einsetzgesteuerte Bandreinigung  
 \_ Unterdruckband  
 \_ Grit Set zur Speicherung der Abtragungsgrade  
 \_ Check Control  
 \_ Touchscreen



## Excel Accesorios Opcionales

\_ Motores de mayor potencia  
 \_ Motores cinta de 2 velocidades  
 \_ Longitud cintas: 2620mm  
 \_ 3 motores independientes en versión con 3 cintas  
 \_ Motovariador velocidad cintas con inverter  
 \_ Tampón elástico y temporizado suplementario  
 \_ Tampón seccionado de accionamiento electrónico  
 \_ Tampón seccionado de accionamiento neumático  
 \_ con temporización  
 \_ Mesa extraíble  
 \_ Rodillo cepillador, rusticador de Tydex, rusticador de acero  
 \_ Rodillo satinador  
 \_ Rodillos temporizados  
 \_ Unidad rodillo regruesador  
 \_ Zapatas prensoras con rodillo incorporado  
 \_ para la mecanización de piezas cortas  
 \_ Unidad sopladores oscilatorios  
 \_ para la limpieza temporizada de las cintas  
 \_ Mesa cinta transportadora por vacío  
 \_ Grit Set para la memorización de grados de extracción  
 \_ Check control  
 \_ Pantalla táctil



# EXCEL CONTROL



**34 Optional**  
 Controllo Touch screen  
 Touch screen control unit  
 Touchscreen-Steuerung  
 Commande Ecran tactile  
 Pantalla táctil de control



**35**  
 Strumentazione elettronica per tampone elettronico  
 Electronic equipment for electronic pad  
 Bedienung für elektronischen Schleifschuh  
 Instruments électroniques pour patin électronique  
 Instrumentación de control para tampón electrónico

**36 Check control**  
 Controllo led per segnalazione eventuali anomalie  
 Malfunction warning LED  
 LED für Störungsanzeige  
 Commande LED pour indication des anomalies  
 Control mediante señal led de eventuales anomalías



**37**  
 Controllo per tampone temporizzato  
 Pad time-control device  
 Bedienung für einsatzgesteuerten Schuh  
 Commande pour patin temporisé  
 Control para tampón temporizado



**38**  
 Visualizzatore elettronico Quota  
 Electronic digital read-out  
 Elektronische Digitalanzeige Arbeitsmass  
 Visualisation de la cote electronique digitale  
 Visualizador de cota electronico digital



# EXCEL



		1NR	2N RT	2N RR	2N RKRT	3N RRR	3N RRT	3N RRKRT	4N RRRR	4N RRRT
Larghezza di lavoro Working width Arbeitsbreite Largeur de travail Ancho da trabajo	mm	1100 1350	1100 1350	1100 1350	1100 1350	1100 1350	1100 1350	1100 1350	1100 1350	1100 1350
Altezza di lavoro min/max Working height Arbeitshöhe Hauteur de travail Altura de trabajo	mm	3/160	3/160	3/160	3/160	3/160	3/160	3/160	3/160	3/160
1° Rullo 1° Roller 1° Rollen 1° Rouleau 1° Rodillo	∅ mm	220-320	180-220	180-220 250-320	180	180-220	180-220	180	180	180
2° Rullo 2° Roller 2° Rollen 2° Rouleau 2° Rodillo	∅ mm	-	-	180-220 250-320	180	220-320	220-320	180	220	220
3° Rullo 3° Roller 3° Rollen 3° Rouleau 3° Rodillo	∅ mm	-	-	-	-	220-320	-	180	220	220
4° Rullo 4° Roller 4° Rollen 4° Rouleau 4° Rodillo	∅ mm	-	-	-	-	-	-	-	320	-
Sviluppo nastri Belts dimensions Cheleifbandabm Dimensions bandes Dimensiones lijas	mm	1120x2150 1370x2150	1120x2150 1370x2150	1120x2150 1370x2150	1120x2150 1370x2150	1120x2150 1370x2150	1120x2150 1370x2150	1120x2150 1370x2150	1120x2150 1370x2150	1120x2150 1370x2150
Velocità nastri calibratura levigatura Speed of calibrating sandpapering belts Vindingkeit des bandes für kalibrierung schleifen Vitesse rubans de calibrage ponçage Velocidad de las bandas lijadoras calibradora	m/s	18	18-16	18-16	18-16	18-16-14	18-16-14	18-16-14	18-18-16-14	18-18-16-14
Potenza motori nastri Power motor belt Motorstärke bander Puissance moteur bandes Potencia motor cintas	kw	11	15	15	15	15-15	15-15	15-15	15-15-15	15-15-15
Motore avanzamento tappeto Feed motor Vorschubmotor Moteur d'entraînement Motor de avance	kw	0,55	0,55	0,55	0,55	1,1	1,1	1,1	1,1	1,1
Motore sollevamento piano Lifting motor Arbeitstichmotor Moteur de soulevement Motor subida-bajada	kw	0,25	0,25	0,25	0,25	0,25	0,25	0,25	0,25	0,25
Aria compressa Compressed air Druckluft Air comprimé Aire comprimido	atm	6	6	6	6	6	6	6	6	6
Aspirazione bocche Suction outlets Absaugmenge anschlube Aspiration goulottes Aspiracion bocas	∅ mm m³/h	1∅160 mm 1900	2∅160+2∅80 3800	2∅160 mm 3800	2∅160+2∅80 3800	3∅160+2∅80 6700	3∅160+2∅80 6700	3∅160+2∅80 6700	4∅160+2∅80 8600	4∅160+2∅80 8600
Peso approssimativo Approximate weight Gewicht Poids approximatif Peso aproximado	kg	1400-1500	1900	1900	1900	2400-2500	2400	2400-2500	3000-3200	3000-3200

## Excel Nastri

Sanding belts  
Bänder  
Bandes  
Cintas



<b>1N R</b>	1 Rullo	
	Roller	
	Walze	
	Rouleau	
	Rodillo	
<b>2N RT</b>	2 Rullo+Tampone	
	Roller + Pad	
	Walze + Schuh	
	Rouleau + Patin	
	Rodillo + Tampón	
<b>2N RR</b>	2 Rulli	
	2 Rollers	
	2 Walzen	
	2 Rouleaux	
	2 Rodillos	
<b>2N RKRT</b>	2 Rullo+Combinato Rullo/Tampone	
	Roller + Roller/Pad Combination	
	Walze + Walzen-Schuh-Kombination	
	Rouleau + Combiné Rouleau/Patin	
	Rodillo + Rodillo/Tampón Combinados	
<b>3N RRR</b>	3 Rulli	
	3 Rollers	
	3 Walzen	
	3 Rouleaux	
	3 Rodillos	
<b>3N RRT</b>	3 2Rulli+Tampone	
	2 Rollers + Pad	
	2 Walzen + Schuh	
	2 Rouleaux + Patin	
	2 Rodillos + Tampón	
<b>3N RRKRT</b>	3 2Rulli+1Combinato Rullo/Tampone	
	2 Rollers + 1 Roller/Pad Combination	
	2 Walzen + 1 Walzen-Schuh-Kombination	
	2 Rouleaux + 1 Combiné Rouleau/Patin	
	2 Rodillo + 1 Rodillo/Tampón combinados	
<b>4N RRRR</b>	4 Rulli	
	4 Rollers	
	4 Walzen	
	4 Rouleaux	
	4 Rodillos	
<b>4N RRRT</b>	4 3 Rulli+Tampone	
	3 Rollers + Pad	
	3 Walzen + Schuh	
	3 Rouleaux + Patin	
	3 Rodillos + Tampón	