

Dok. Typ	Detailschnitt
System	Holz-Fenster 68mm
Typ	Fenster
Schnitt	Unten
Details	Außen: Aluminium-Fensterbankfalz Innen: Fensterbankfalz 30/12
Maßstab 1:1	

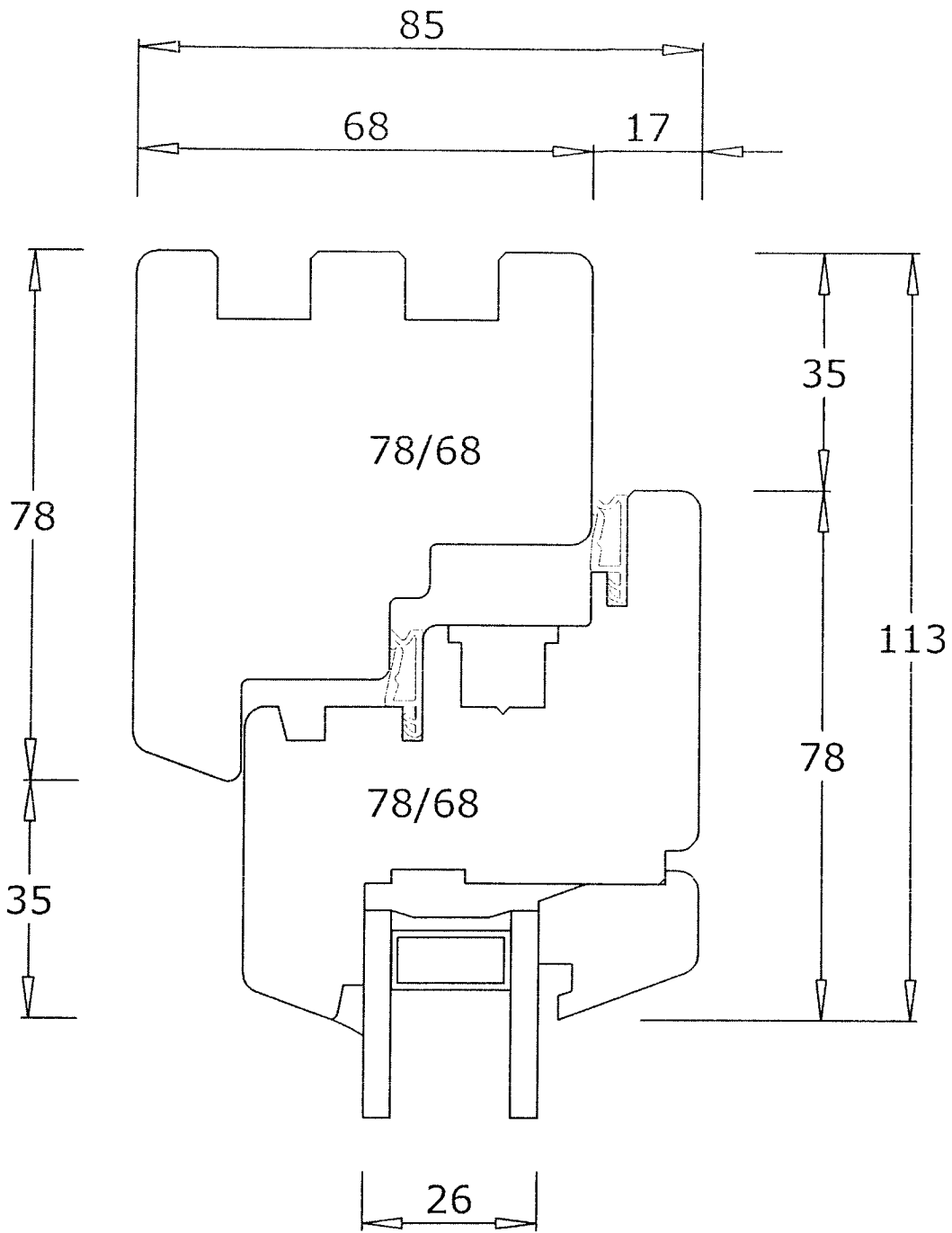

Dok. Typ	Detailschnitt
System	Holz-Fenster 68mm
Typ	Fenster
Schnitt	Oben
Details	Koppelnut
Maßstab 1:1	

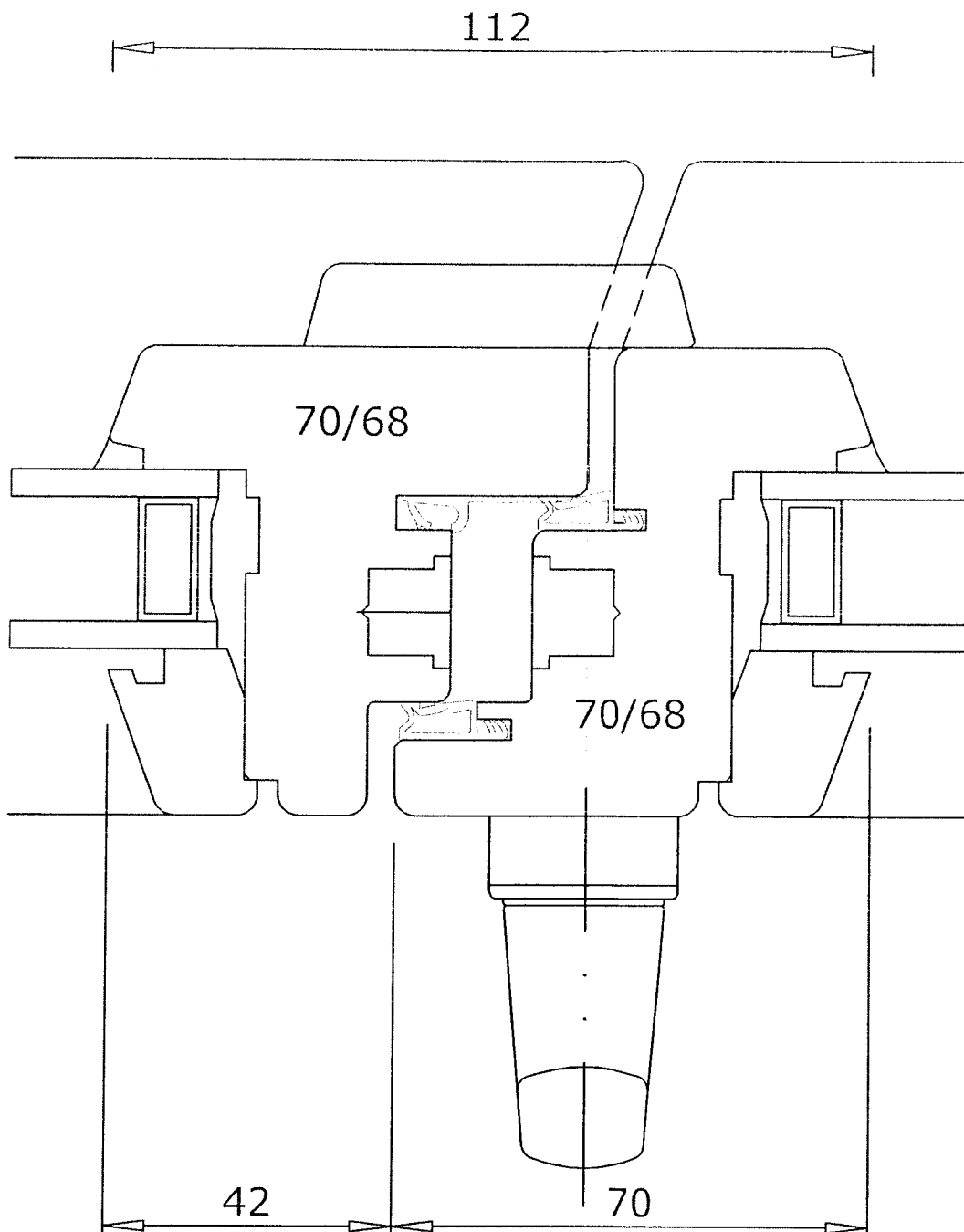

Dok. Typ	Detailschnitt
System	Holz-Fenster HISTORIK 68mm
Typ	Fenster
Schnitt	Stulppartie
Details	
Maßstab 1:1	

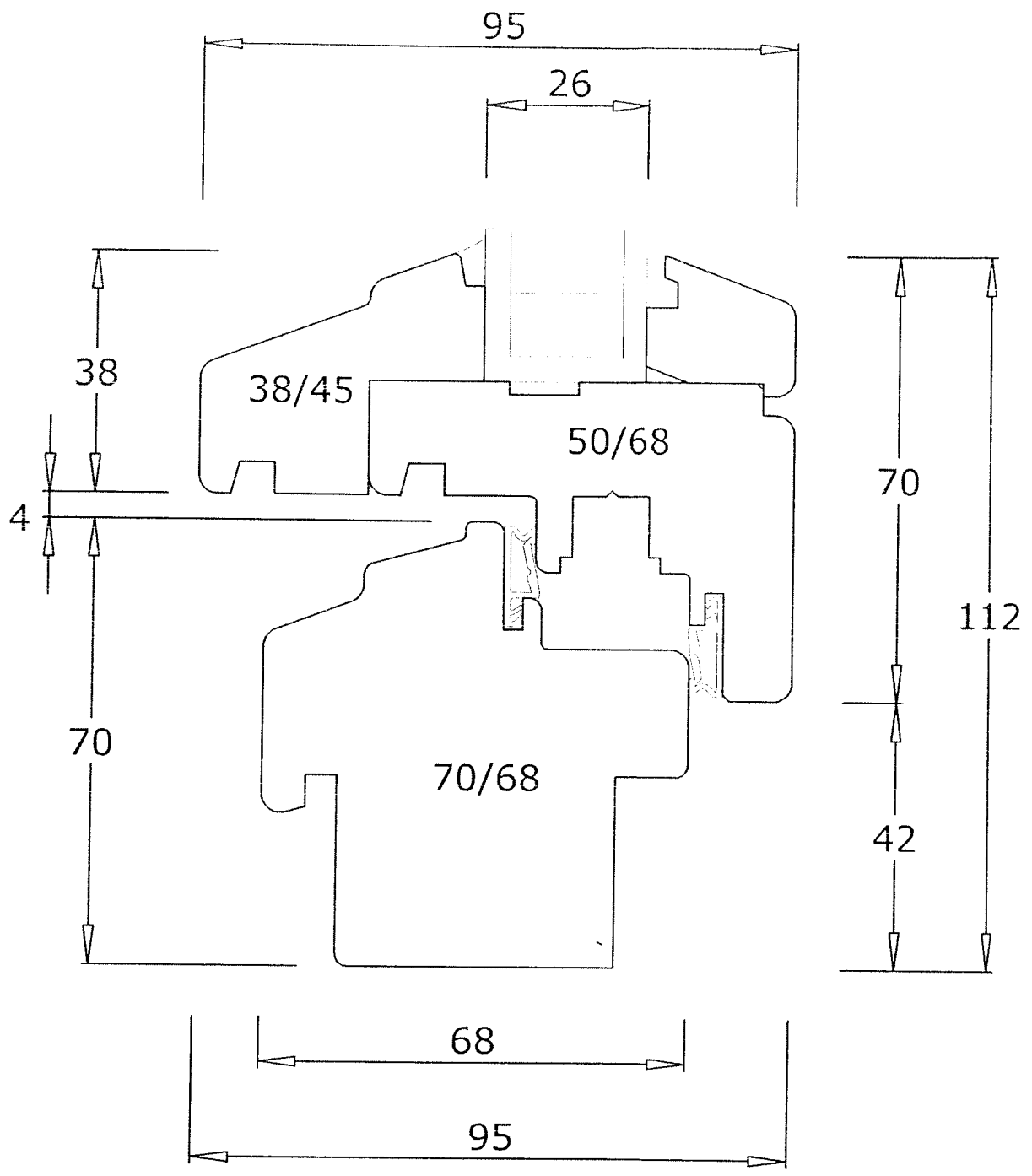

Dok. Typ	Detailschnitt
System	Holz-Fenster HISTORIK 68mm
Typ	Fenster
Schnitt	Unten
Details	Außen: Aluminium-Fensterbankfalz
Maßstab 1:1	Innen: Fensterbankfalz 30/12

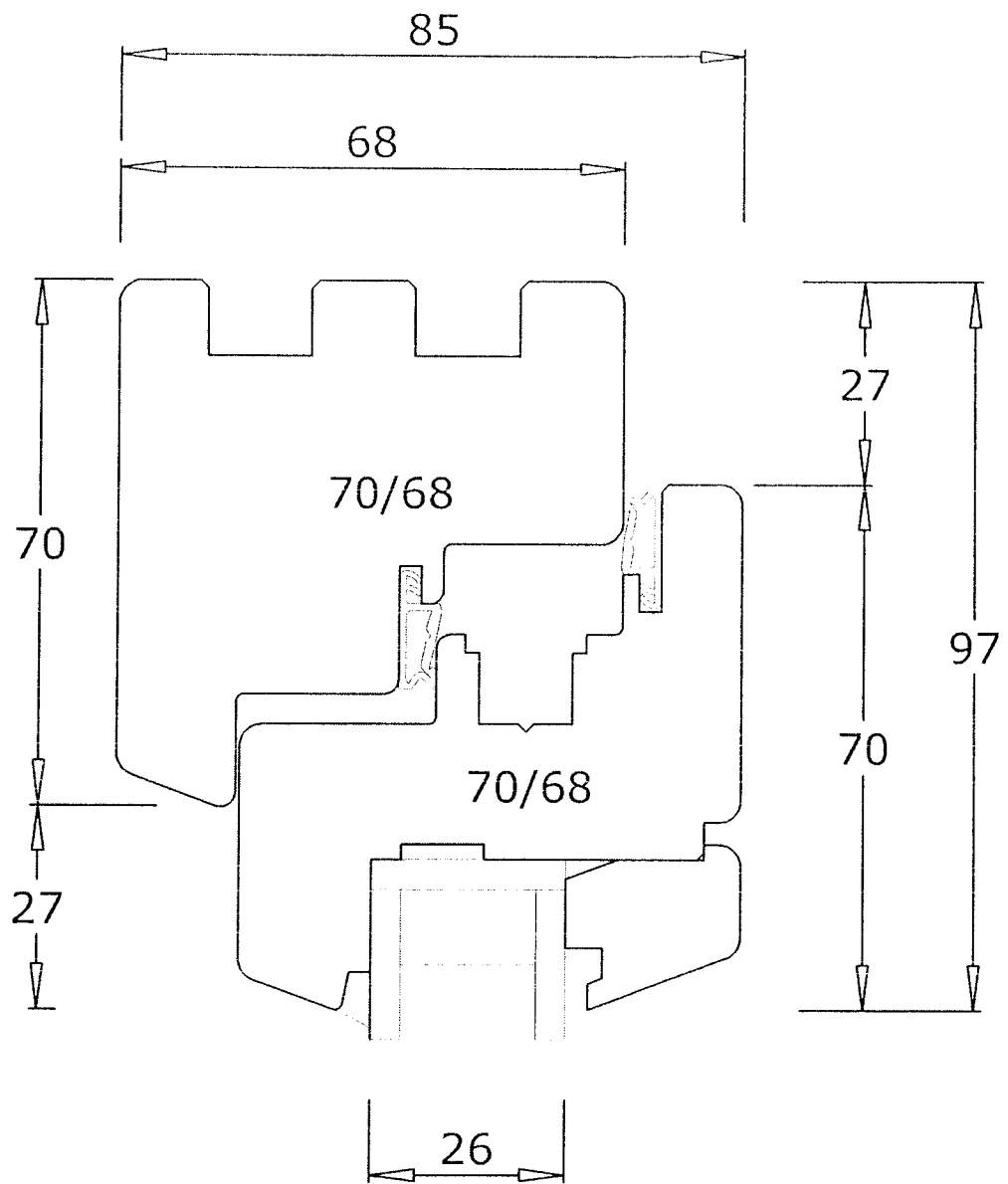

Dok. Typ	Detailschnitt	
System	Holz-Fenster HISTORIK 68mm	
Typ	Fenster	
Schnitt	Oben	
Details	Koppelnut	
Maßstab	1:1	

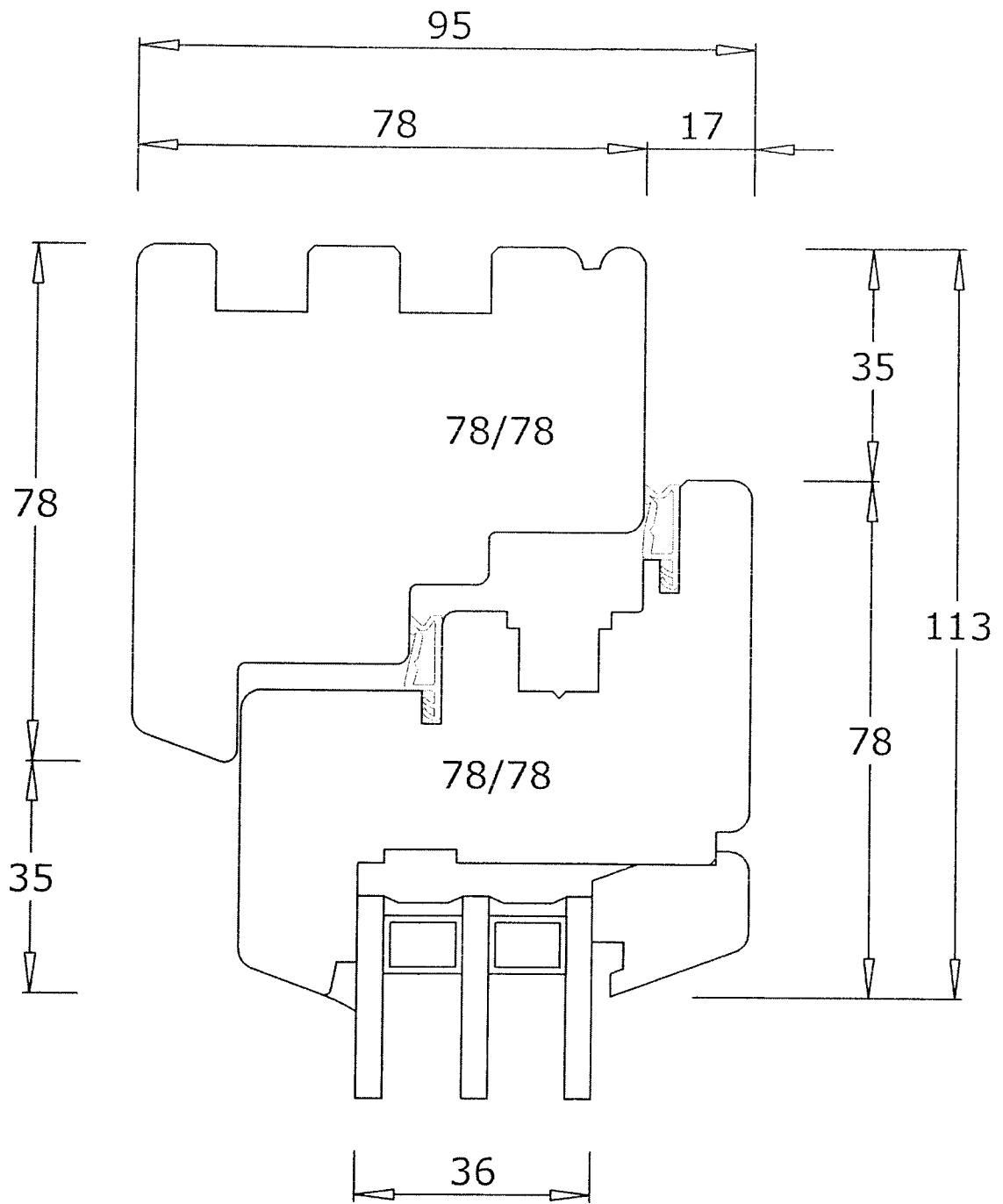

Dok Typ	Detailschnitt
System	Holz-Fenster 78mm
Typ	Fenster
Schnitt	Oben
Details	Koppelnut
Maßstab	1:1

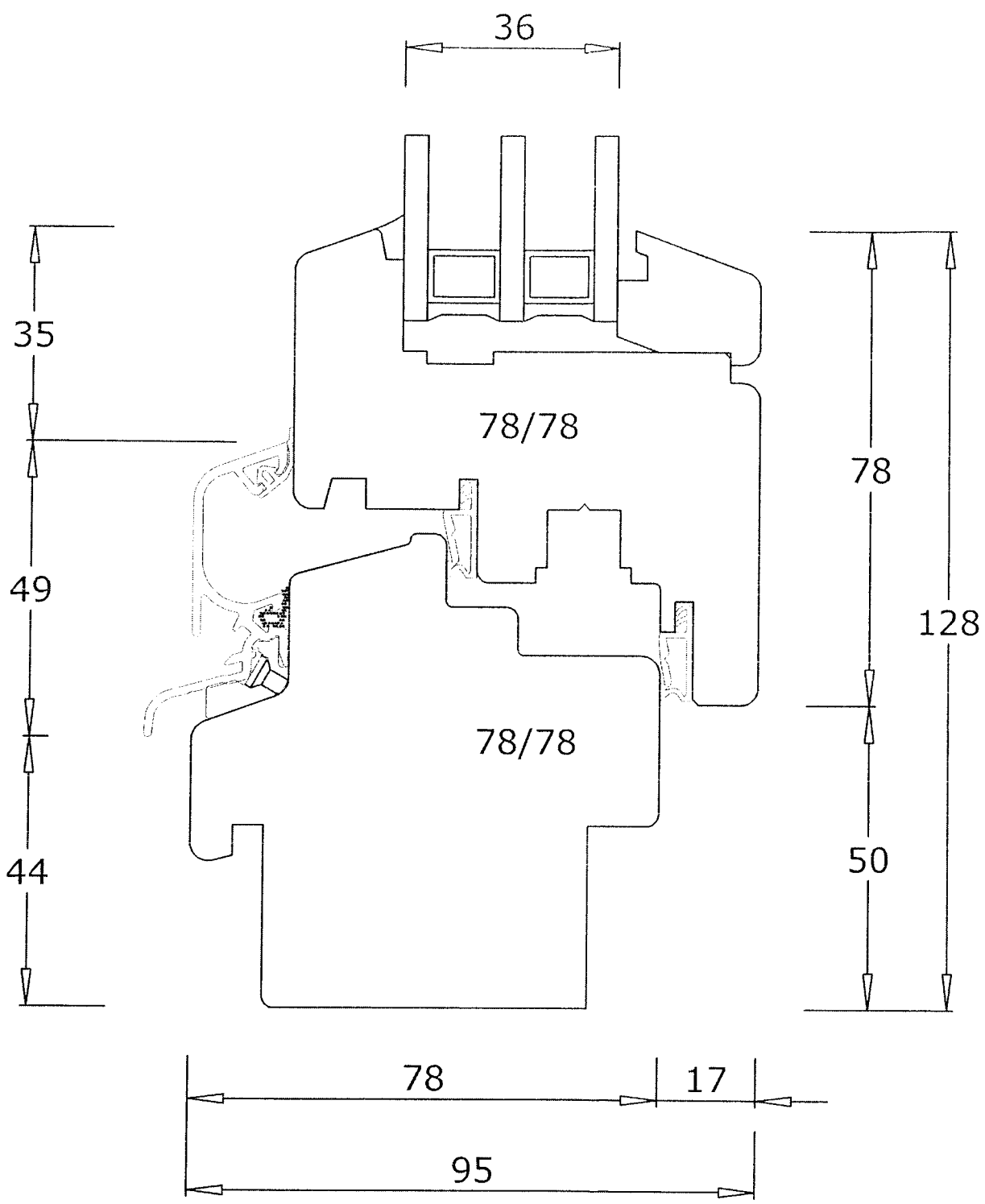

Dok. Typ	Detailschnitt
System	Holz-Fenster 78mm
Typ	Fenster
Schnitt	Unten
Details	Außen: Aluminium-Fensterbankfalz Innen: Fensterbankfalz 30/12
Maßstab 1:1	

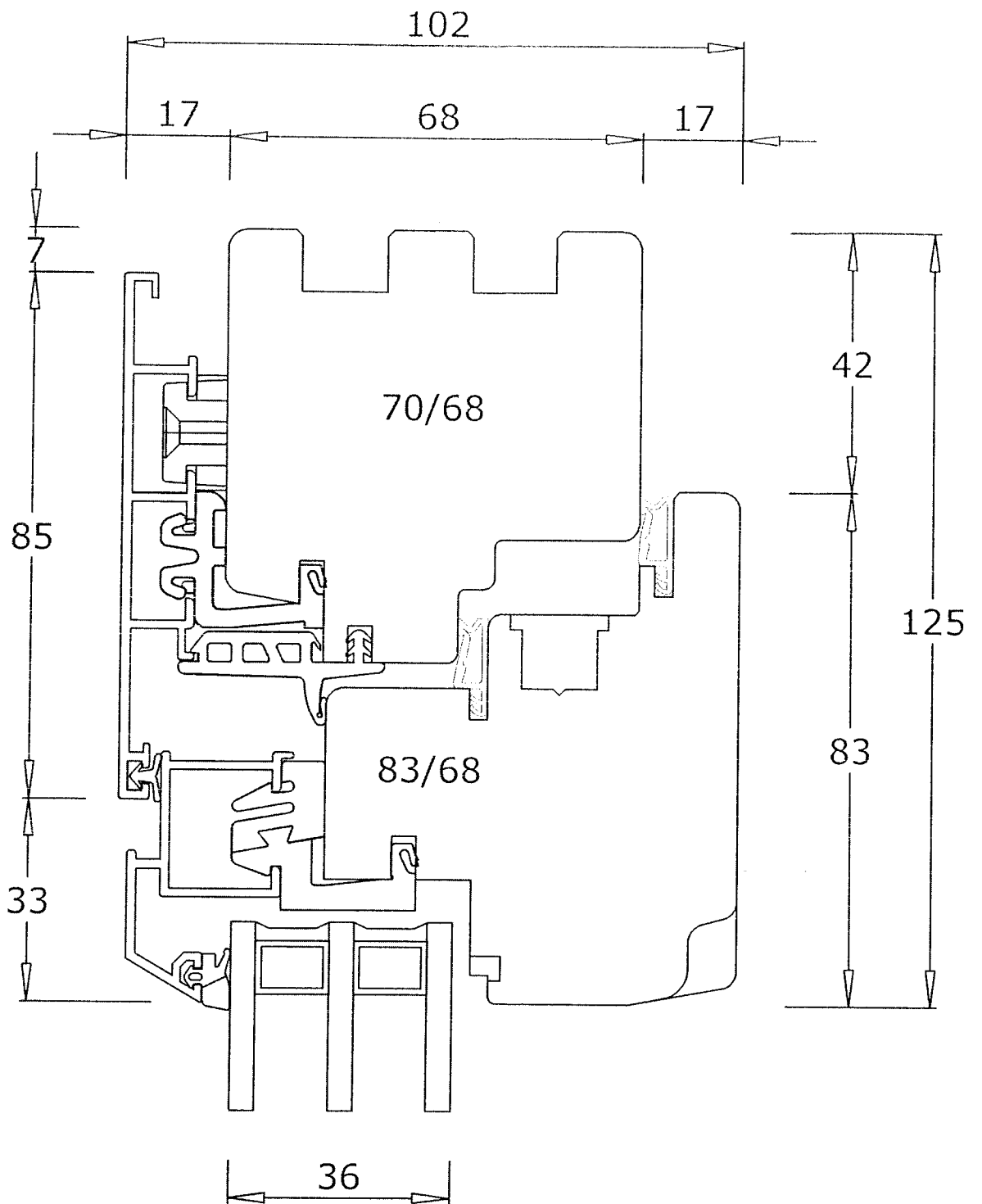

Dok. Typ	Detailschnitt
System	IV78
Typ	Fenster
Schnitt	Oben
Details	Außen: Aluminium-Fensterbankfalz Innen: Fensterbankfalz 30/12
Maßstab 1:1	

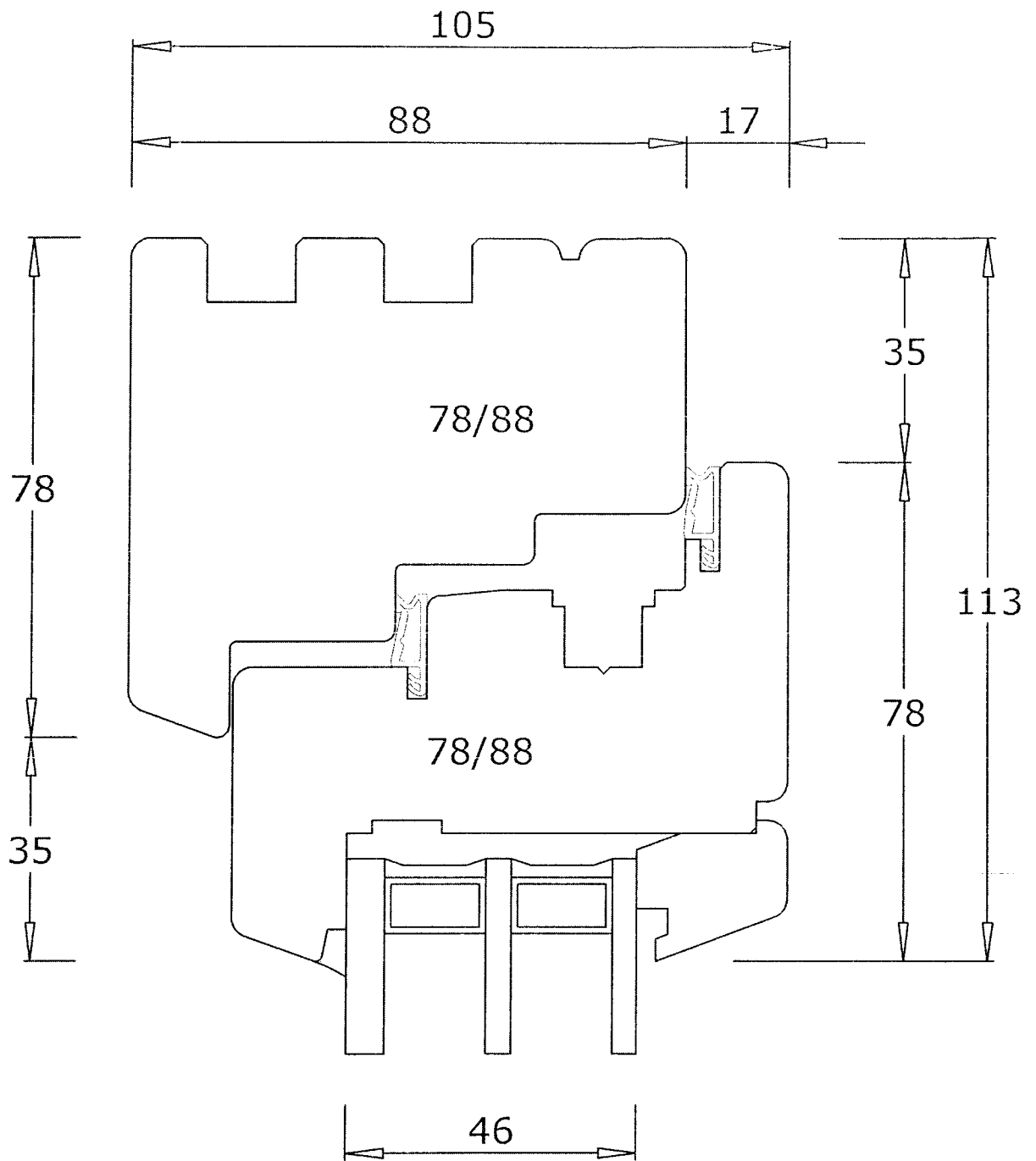

Dok. Typ	Detailschnitt	
System	Holz-Fenster 88mm	
Typ	Fenster	
Schnitt	Oben	
Details	Koppelnut	
Maßstab 1:1		

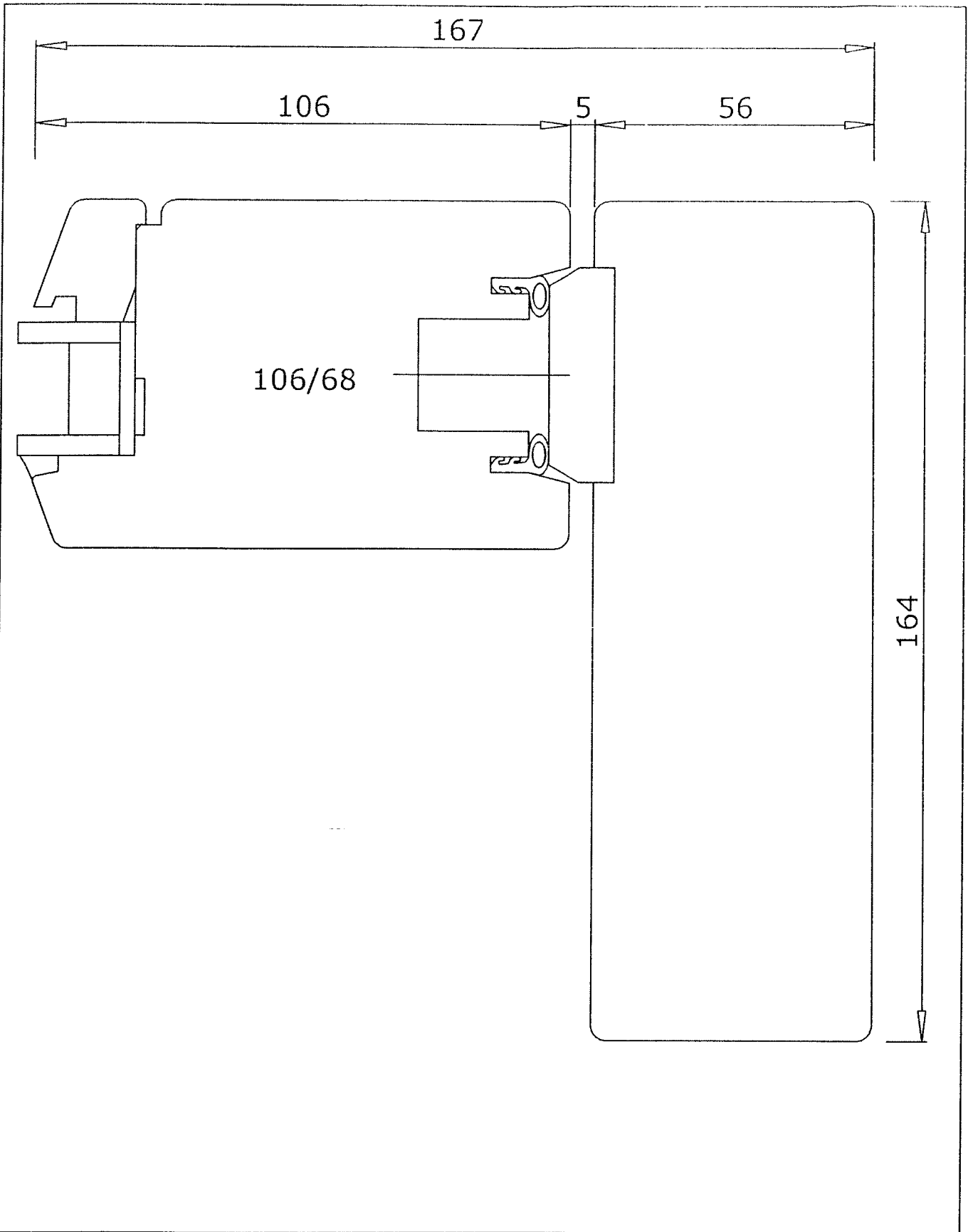

Dok. Typ	Detailschnitt
System	Holz Fenster 68mm
Typ	Hebe-Schiebetür
Schnitt	Bewegter Flügel Rechts
Details	
Maßstab 1:1	

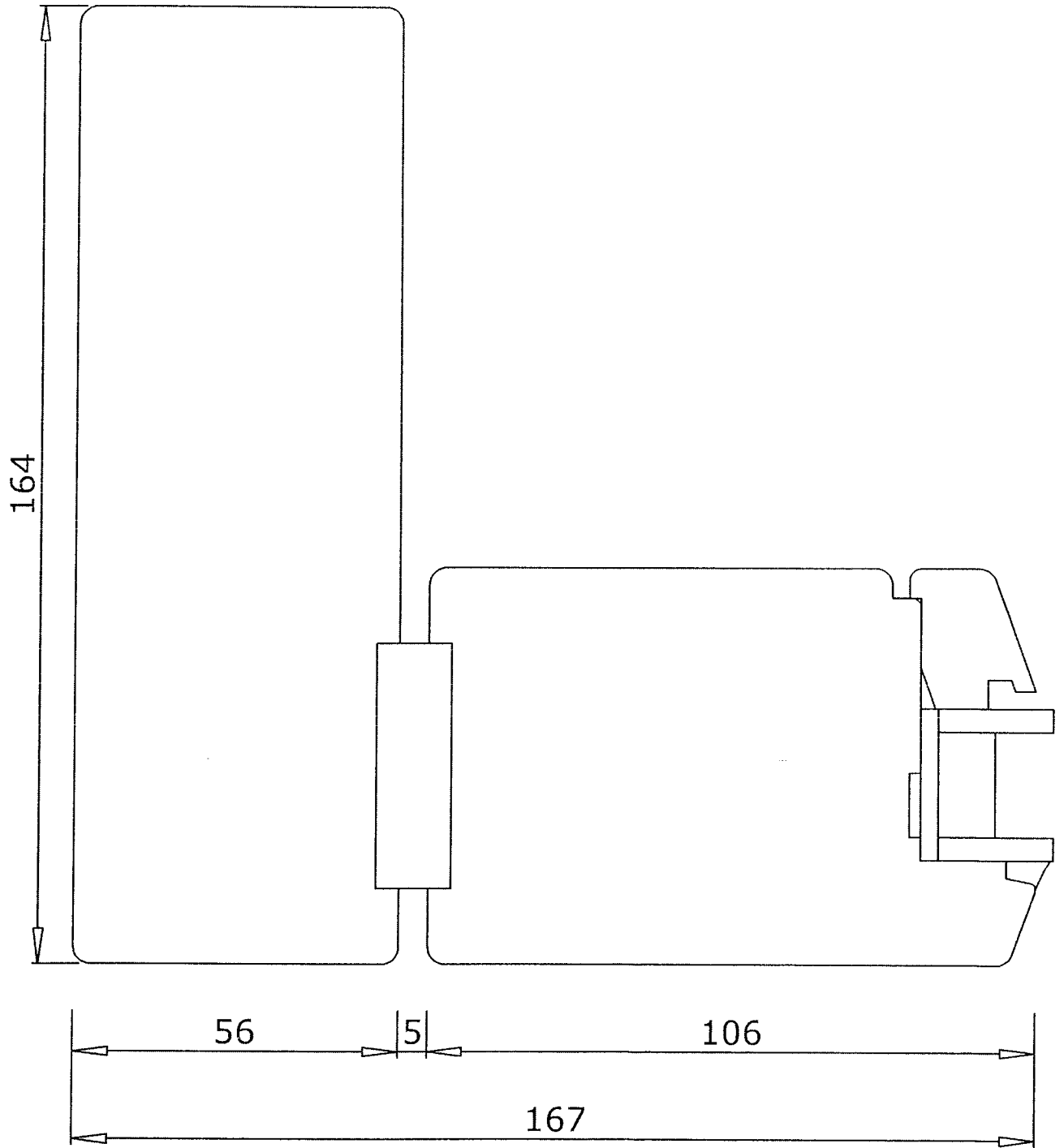

Dok. Typ	Detailschnitt	
System	Holz Fenster 68mm	
Typ	Hebe-Schiebetür	
Schnitt	Festflügel Links	
Details		
Maßstab 1:1		

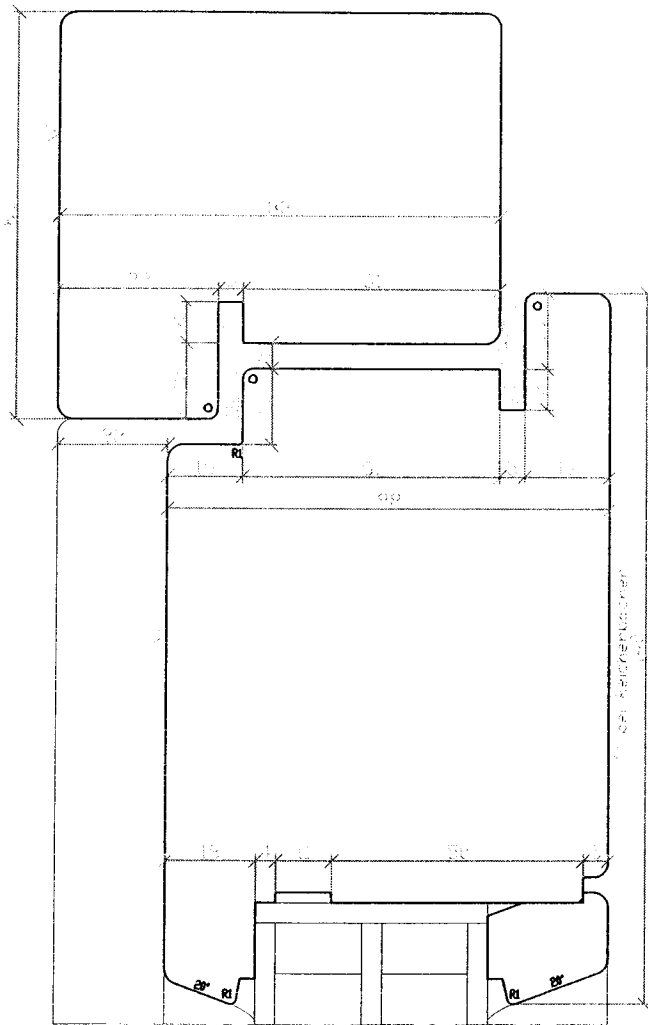

20
 Beschriftung: Holz für
 oder Stahl für
 20
 40
 100
 20, 4mm

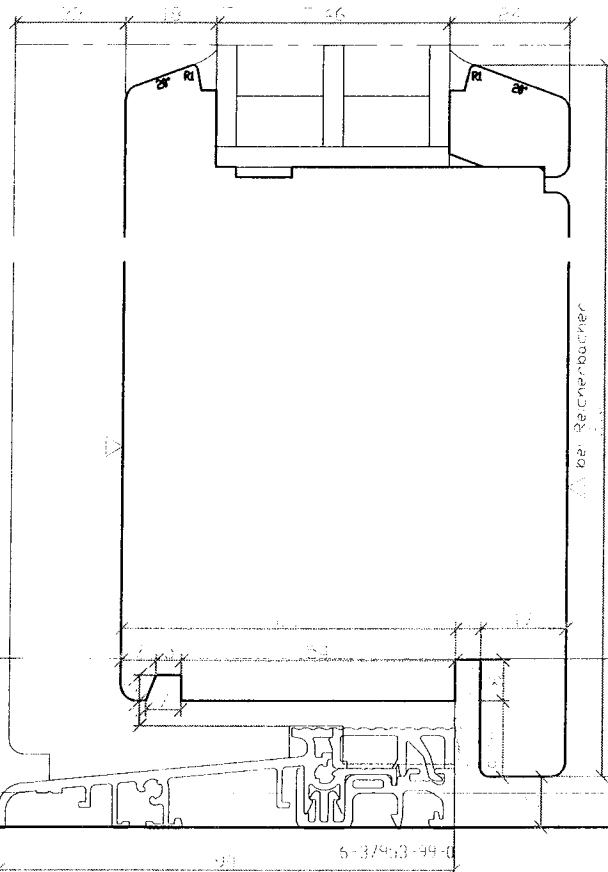

Holz Haustür

Bestandteile: Holz
oder Stahl

Höhe: 20,3mm

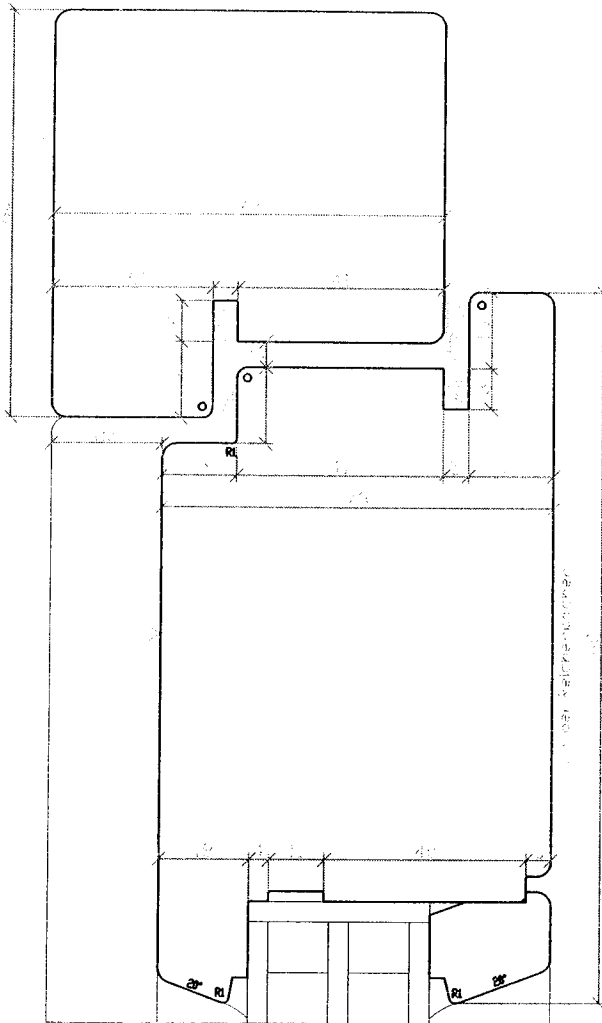

Holz Haustür

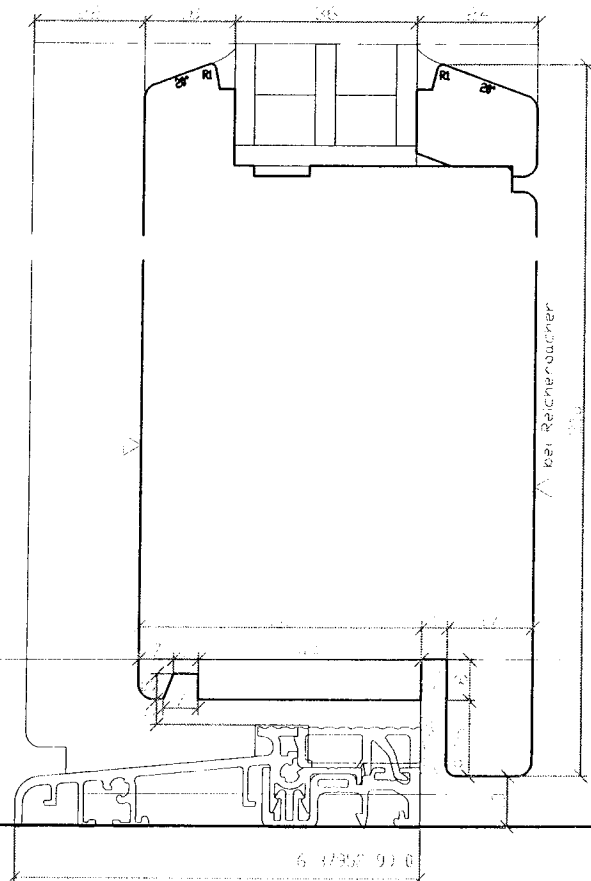

Beventil, BFD 30
oder Bhat 6

Fig. 20, 3mm

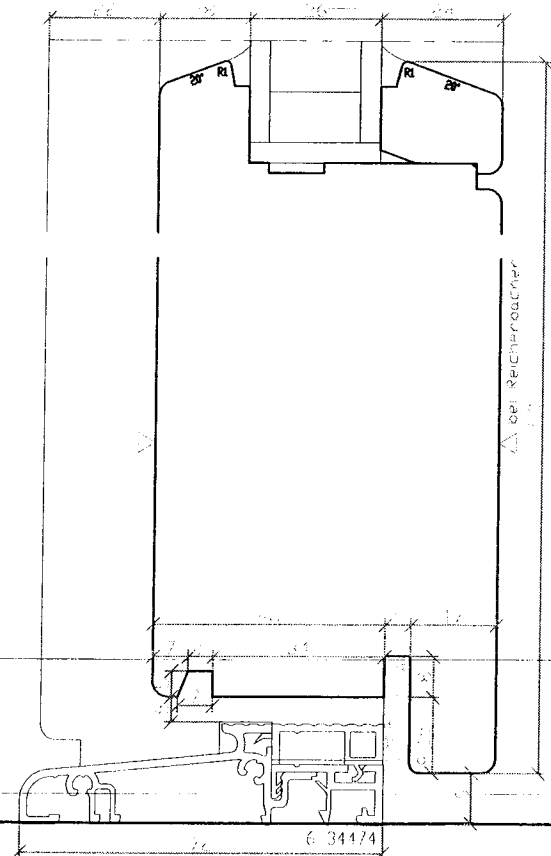
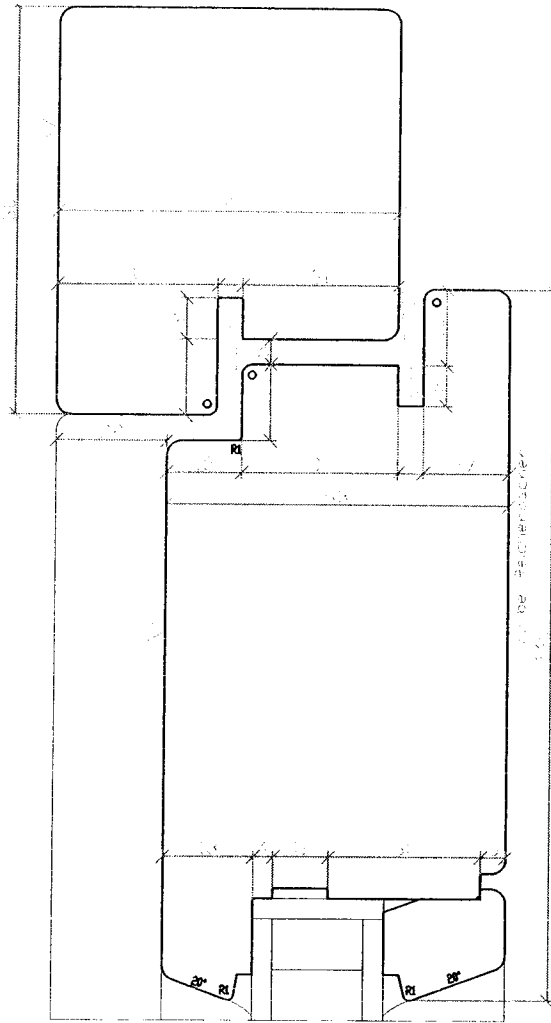

Holz Haustür

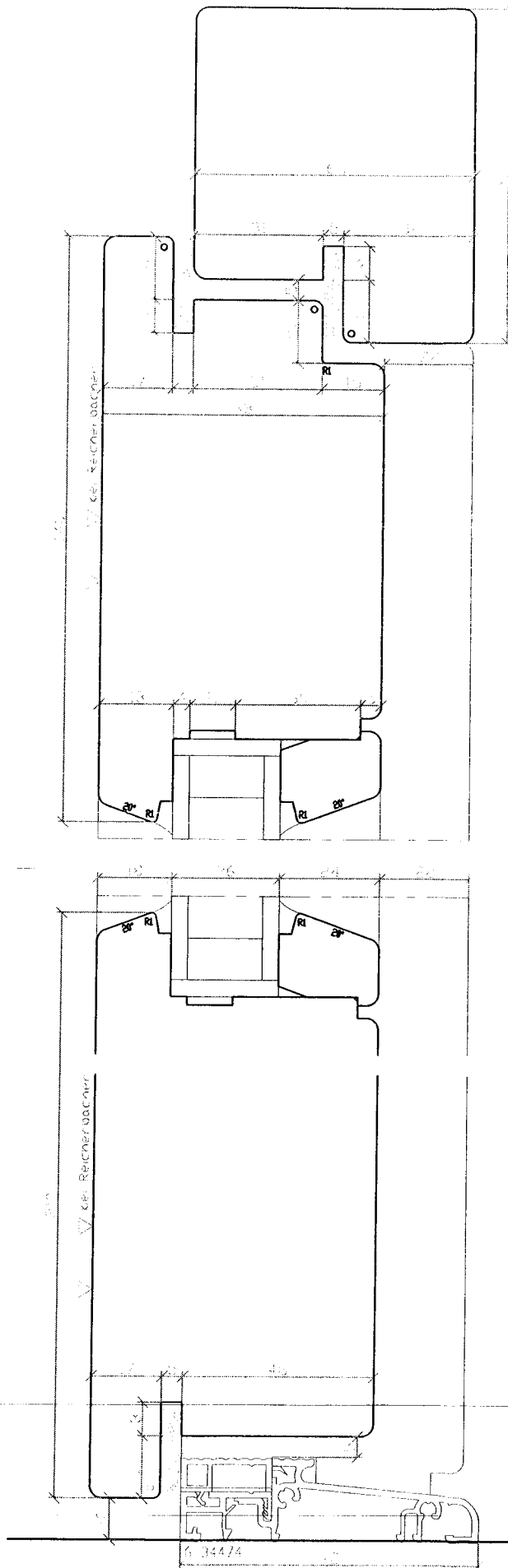

beventilt - IS 1/2
 oder - druck
 K&E 20, 2mm

Holz Haustür
 außen öffnend

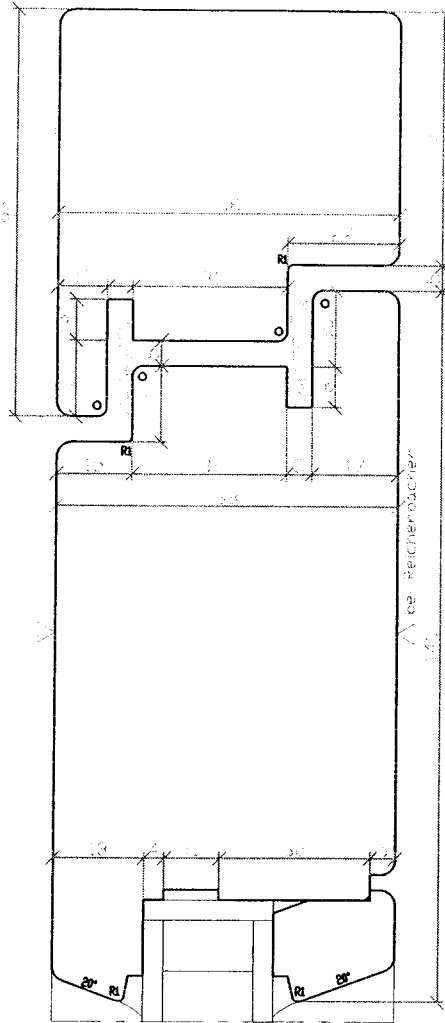

Bewerber: 101700
 oder: 101700
 KG: 20,3mm

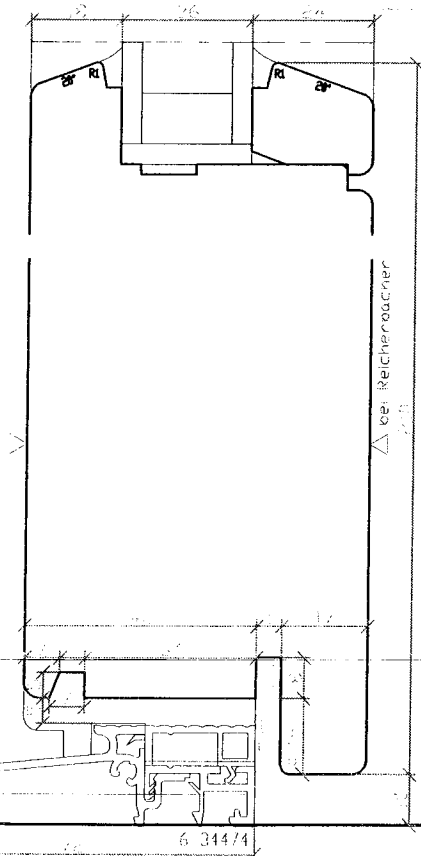
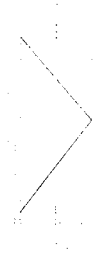

Holz Haustür
 flächenbündig

Bezeichnet Bild mit
oder ohne B
Fl. 20, 3mm

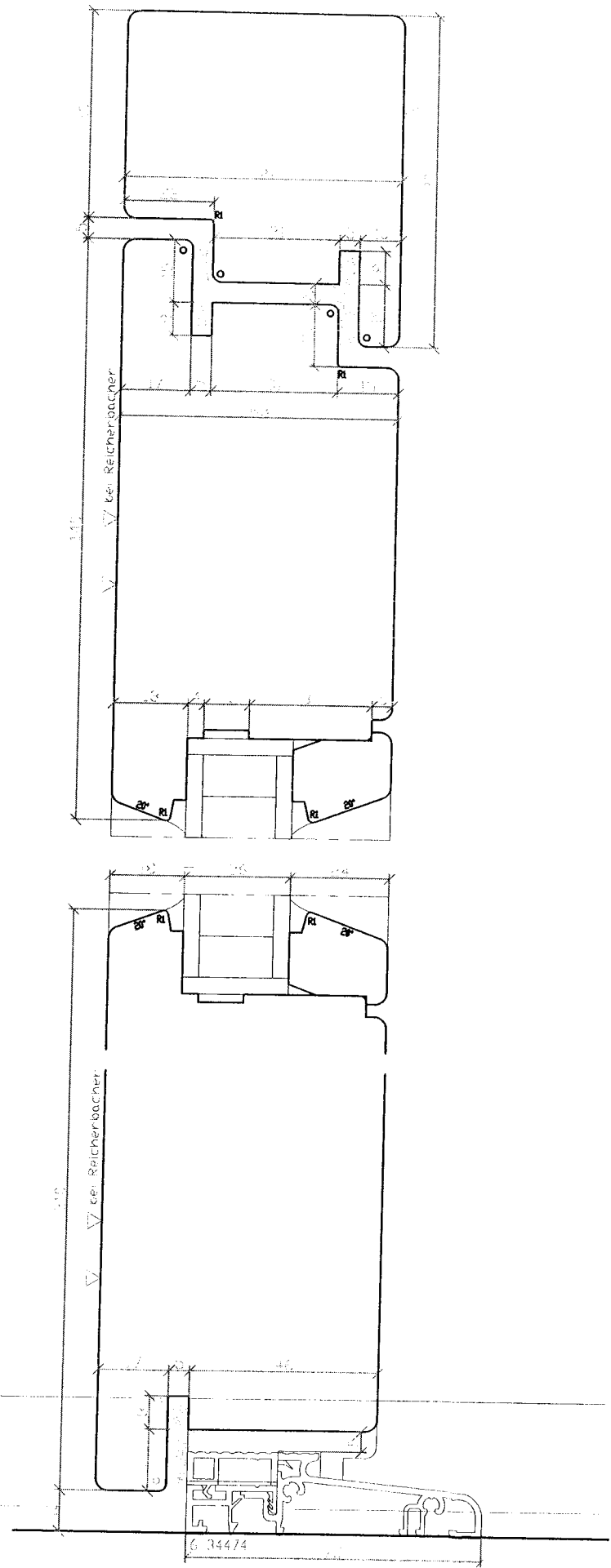
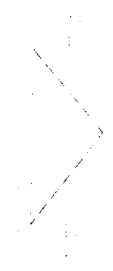

Holz Haustür
flächenbündig
außen öffnend

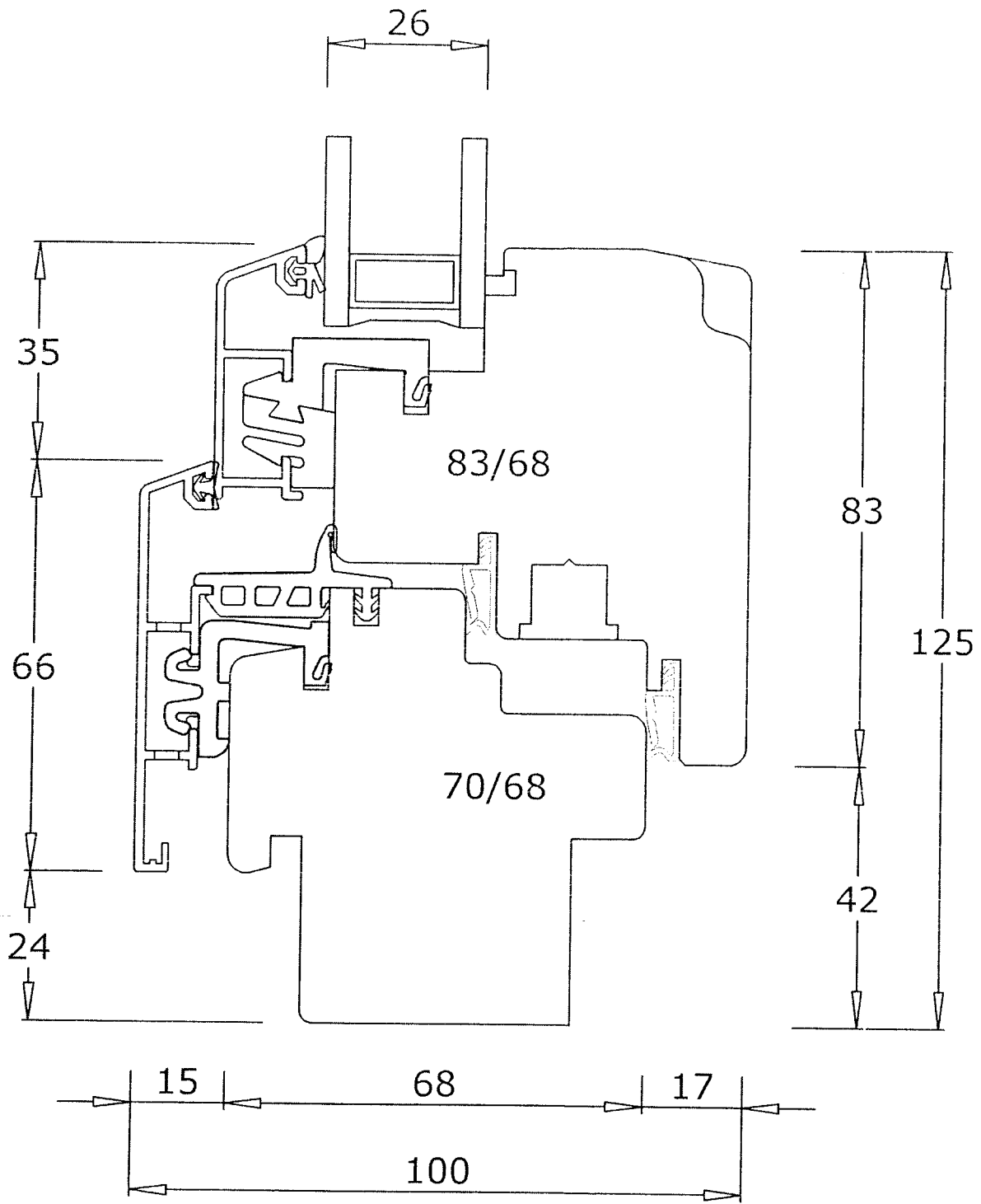

Dok. Typ	Detailschnitt
System	Holz-Aluminium Fenster 68mm
Typ	Fenster
Schnitt	Unten
Details	Außen: Aluminium-Fensterbankfalz Innen: Fensterbankfalz 30/12
Maßstab 1:1	

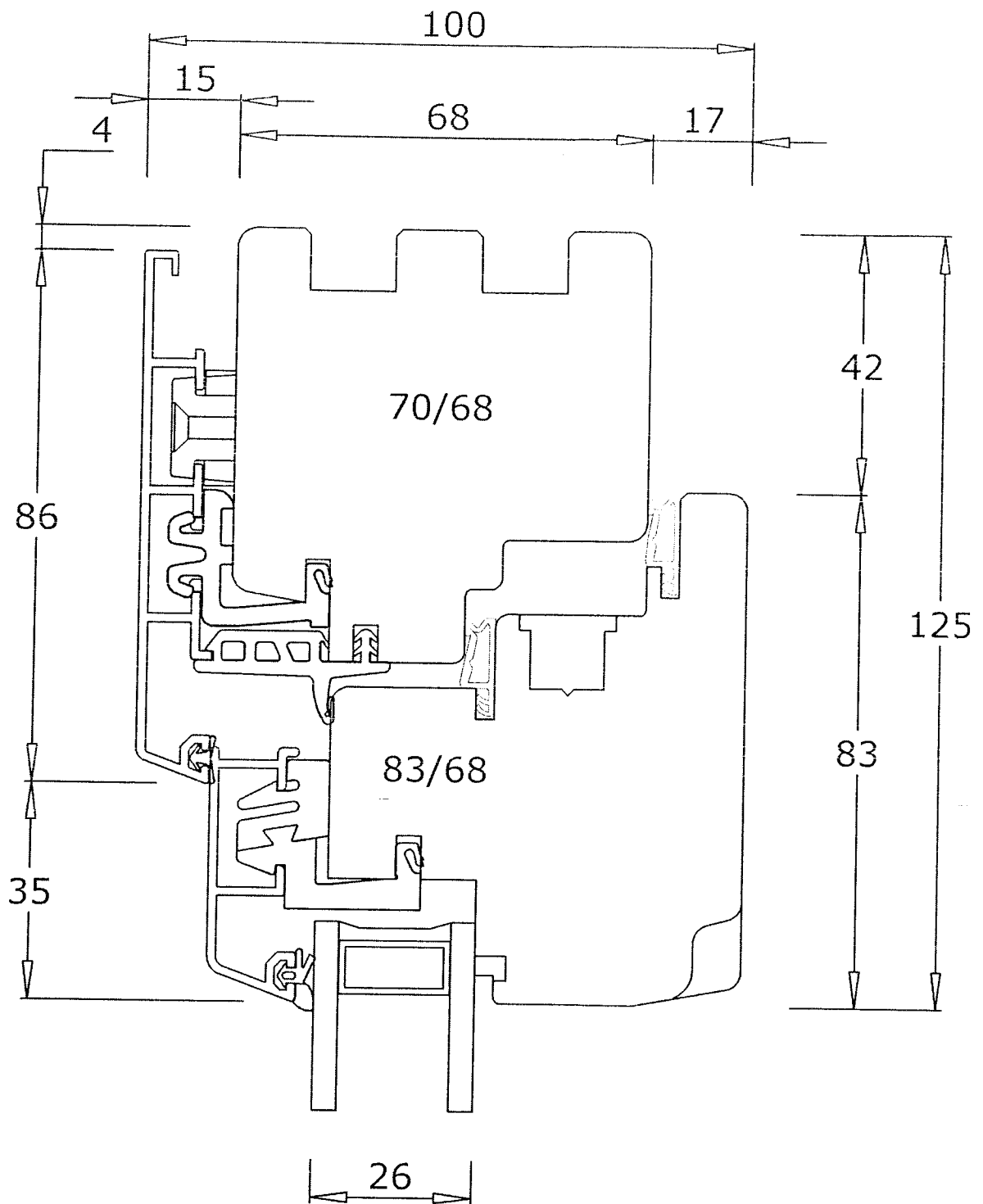

Dok. Typ	Detailschnitt
System	Hotz-Aluminium Fenster 68mm
Typ	Fenster
Schnitt	Oben
Details	Koppelnut
Maßstab	1:1

FWT 50-1 HA E

Holz-Aluminium-Fassade
mit Elastomerschaumkeder

Anwendungsbeispiel 3-Ebenendichtung Wandanschluss seitlich

- In Abhängigkeit von Innenraumbedingungen, Art und Oberflächenbehandlung der Holzprofile sind gg. falls zusätzlich Dampfbremsen anzubringen.

Falls erforderlich Abklärung mit Bauphysiker

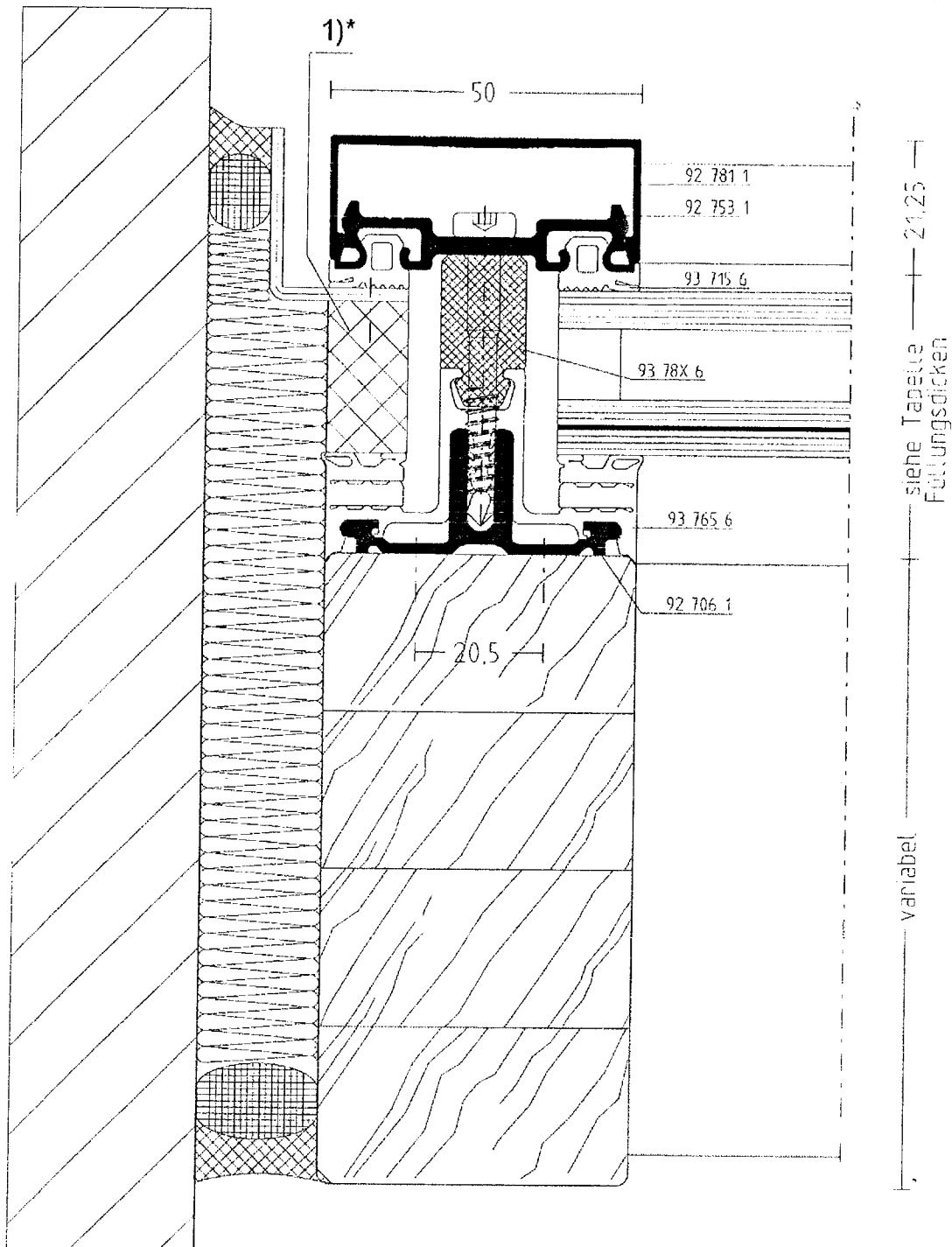

1*) Umleimer druck- und verrottungsfest, wärmedämmend z.B. aus Purenit, Phonotherm, Linirec oder gleichwertig, verkleben mit Butylband. (Eigenfertigung)
Abdichten von Stößen und Gehrungsecken mit geeignetem Dichtstoff

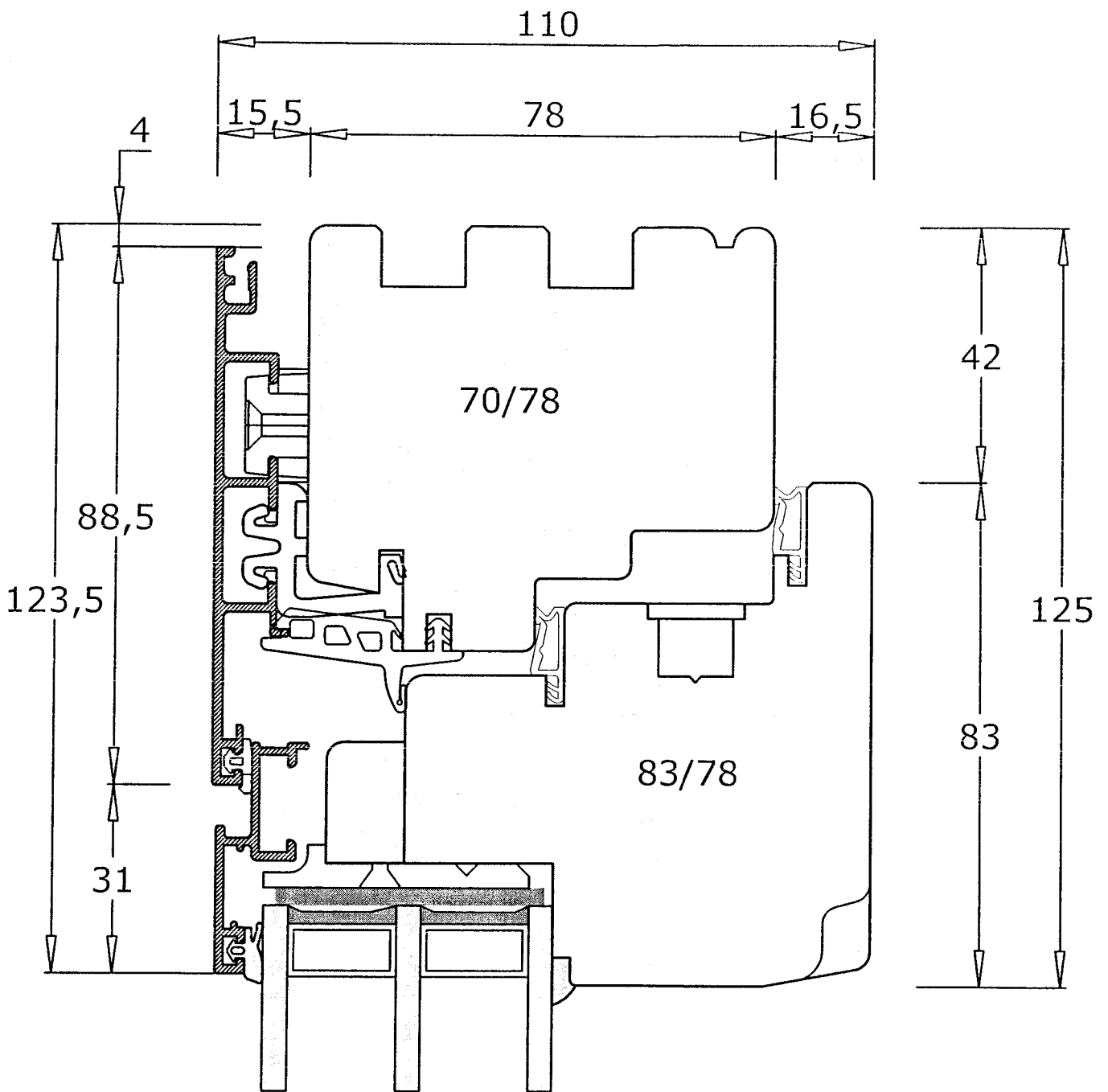

Dok. Typ	Detailschnitt
System	Holz-Aluminium Fenster 78mm FLATLINE
Typ	Fenster
Schnitt	Oben
Details	
Maßstab 1:1	

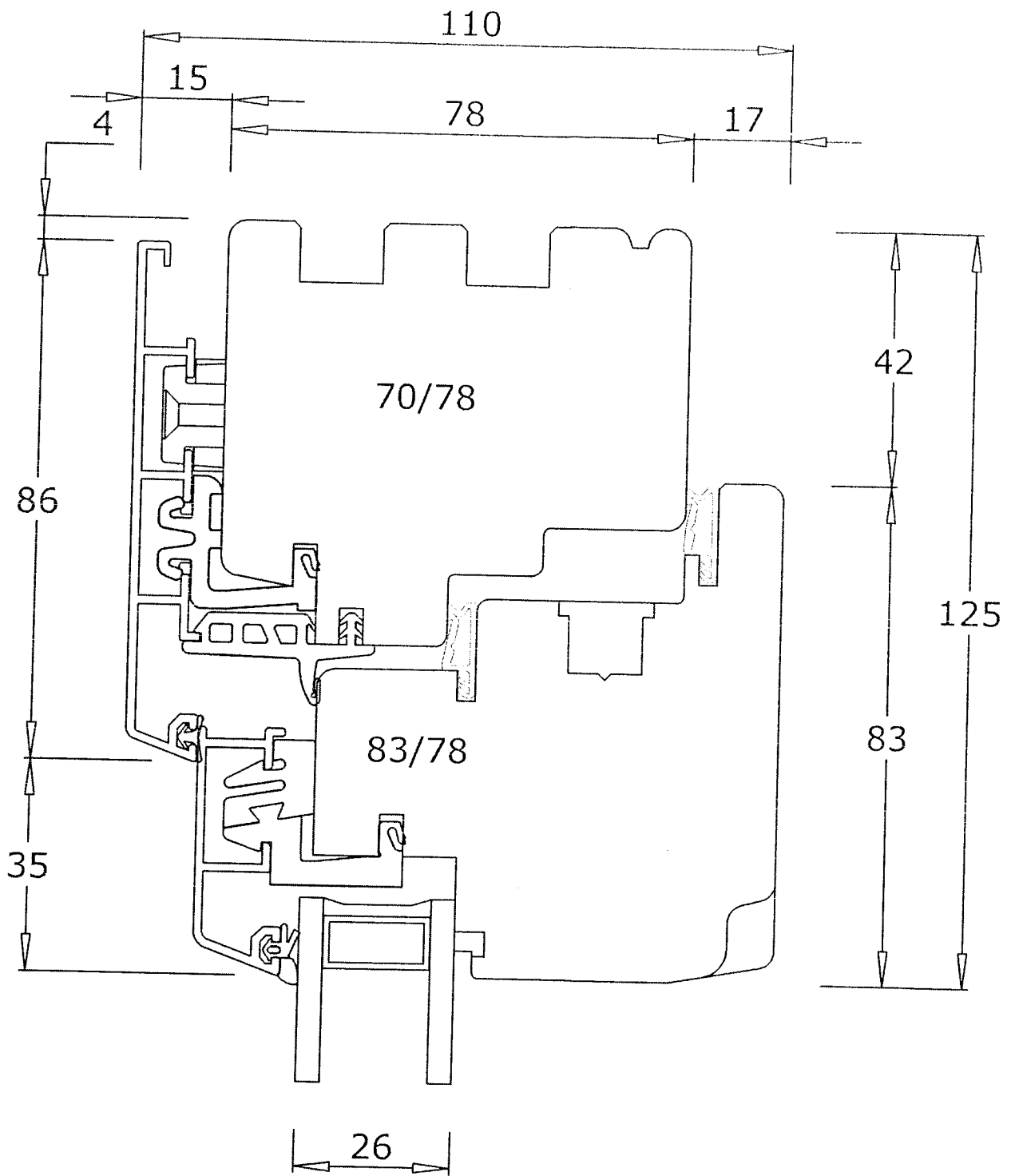

Dok. Typ	Detailschnitt
System	Holz-Aluminium Fenster 78mm
Typ	Fenster
Schnitt	Oben
Details	Koppelnut
Maßstab	1:1

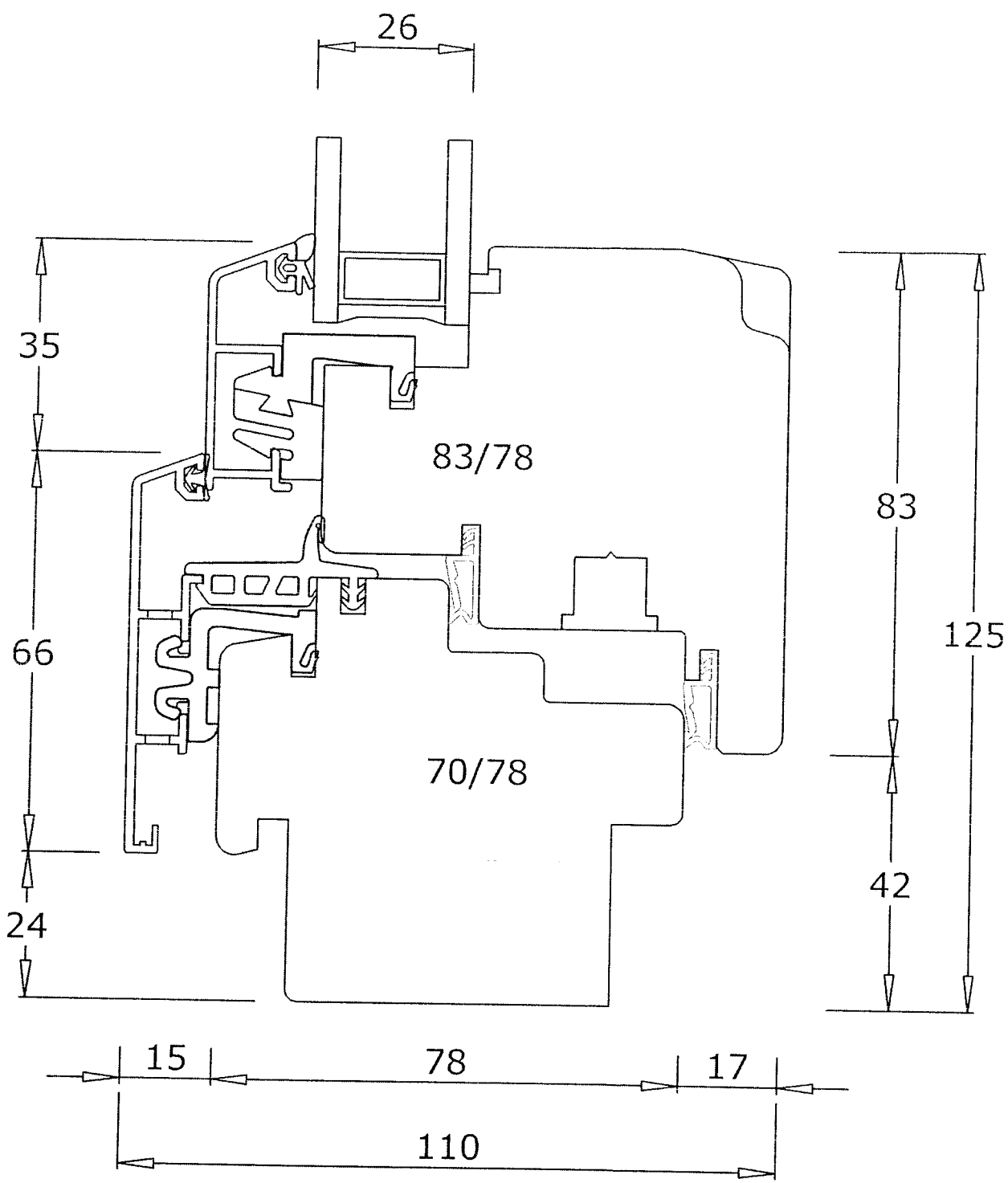

Dok. Typ	Detailschnitt
System	Holz-Aluminium Fenster 78mm
Typ	Fenster
Schnitt	Unten
Details	Außen: Aluminium-Fensterbankfalz Innen: Fensterbankfalz 30/12
Maßstab	1:1

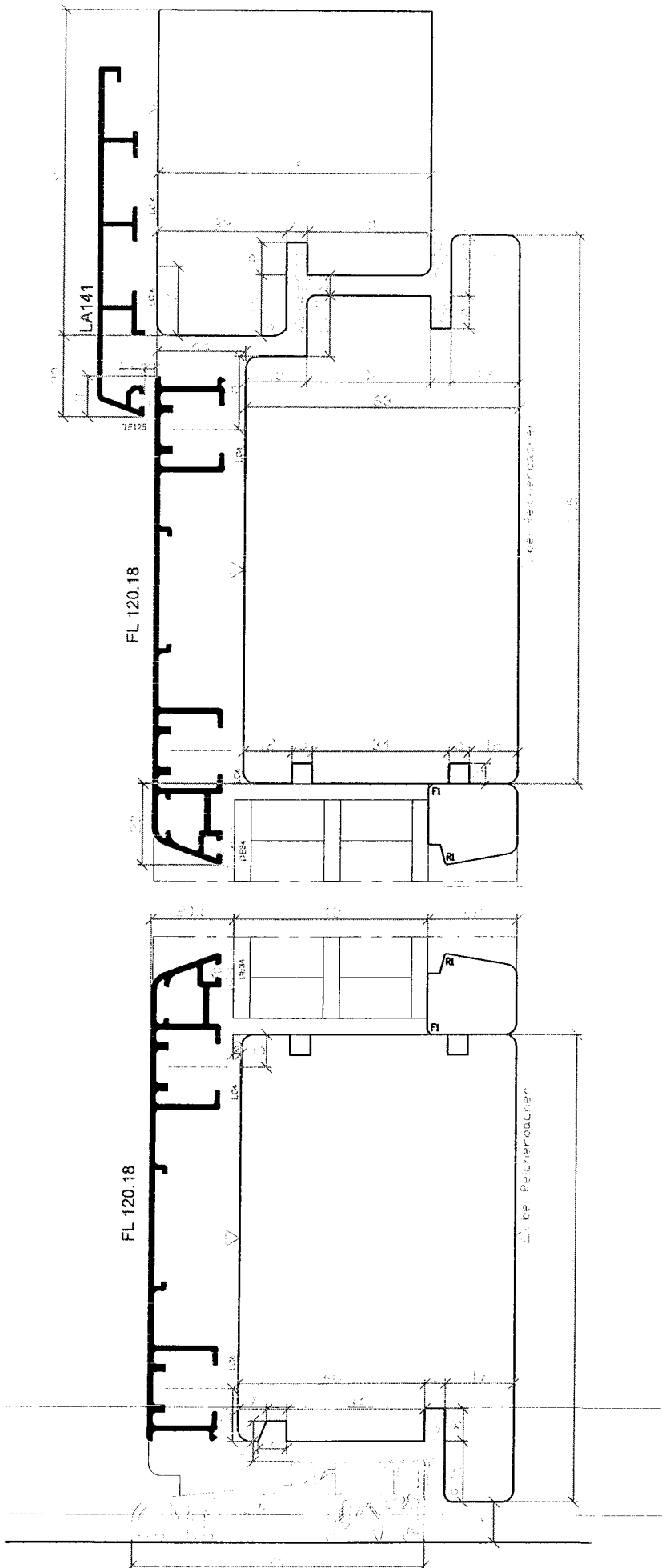

Hersteller: PE8K
 oder: abm 1

FL 120, 3mm



100% PE8K-Produktion

Holz-Alu Haustür